

METAL RETROFIT

EPDM Metal Retrofit Roofing System

TABLE OF CONTENTS

July 2013

PART I - General		Page
1.01	Description.....	3
1.02	General Design Considerations.....	3
1.03	Quality Assurance.....	4
1.04	Submittals.....	4
1.05	Warranty.....	5
1.06	Job Conditions.....	5
1.07	Product Delivery, Storage and Handling.....	6
PART II – Products		
2.01	General.....	6
2.02	Membrane/Details.....	6
PART III – Execution		
3.01	General.....	8
3.02	Existing Metal Roof Criteria.....	8
3.03	Substrate Preparation.....	8
3.04	Installation.....	9
DETAILS		
	Installation Details.....	11

METAL RETROFIT

EPDM Metal Retrofit Roofing System

July 2013

The information contained in this generic specification represents a part of Carlisle's requirements for obtaining a roofing systems warranty. Construction materials and practices, building siting and operation, climatic conditions, and other site-specific factors will have an impact on the performance of the roofing system. Carlisle recommends that the building owner retain a design professional to determine appropriate design measures to be taken in order to address these factors.

This section is to serve as criteria for Specifiers and Authorized Applicators regarding the design and installation of Carlisle's EPDM Metal Retrofit Roofing System. Additional information essential for the design and installation of the roof system mentioned herein are also included in the Design Reference Section and also listed in the form of a Specification Supplement at the end of the Technical Manual. Specifiers and Authorized Applicators are advised to reference all applicable sections.

PART I – GENERAL

1.01 Description

- A. **Mechanically Fastened Membrane Assemblies** incorporates **45, 60 or 75-mil Sure-Tough reinforced EPDM membrane (Available in Black Only)**. An acceptable insulation used to fill between standing seams and an acceptable insulation or underlayment is mechanically secured over the fill insulation, to the existing metal roof with Carlisle fasteners and plates, then the EPDM membrane is secured with 9" wide Pressure-Sensitive Reinforced Universal Securement Strip (RUSS) positioned along the structural purlins in the field of the roof (5' or 10' depending on wind zone). The RUSS is attached to the purlins a maximum of 12" on center utilizing Sure-Seal HP Purlin Fasteners and Polymer Seam Plates. The membrane is adhered to the RUSS and adjoining sheets are spliced together using Factory-Applied TAPE (FAT) and Primer or 6" SecurTAPE and Primer
- B. **Adhered Membrane Assemblies** incorporates **Sure-Seal (black) or Sure-White (white-on-black) 60 or 90-mil thick non-reinforced OR 45, 60 or 75-mil Sure-Tough™ (black) reinforced EPDM membrane OR Sure-Seal/Sure-White 105, 115 or 145-mil FleeceBACK membrane**. An acceptable insulation is mechanically secured over the fill insulation, to the existing metal roof with Carlisle fasteners and plates. The EPDM membrane is adhered to the insulation with Carlisle EPDM Bonding Adhesive (Sure-Seal Bonding Adhesive, Low-Voc Bonding Adhesive, Solvent-Free Bonding Adhesive or Water Based Adhesive). Adjoining sheets of EPDM membrane are spliced together using 3" or 6" wide SecurTAPE™ and Primer OR Factory-Applied TAPE (FAT™) and Primer. The FleeceBACK membrane is fully adhered to an acceptable substrate with a spray or extrusion applied, two component, low rise FAST™ Adhesive. Adjoining sheets of membrane are spliced together using 3" or 6" wide Factory-Applied SecurTAPE™ in conjunction with EPDM Primer.

NOTE: Carlisle low rise polyurethane adhesive may be used in lieu of fasteners for insulation fill and membrane underlayment.

1.02 General Design Considerations

- A. It is the responsibility of the building owner or his/her designated representative to verify structural load limitation.

- B. Existing venting around edges and wall intersections should not be closed off unless determined by designer of record. Refer to applicable details included in this section for recommended venting methods. Specific details may be submitted for Carlisle review.

1.03 Quality Assurance

Building Codes are above and beyond the intended purpose of this specification. The respective **owner** or **specifier** should consult local codes for applicable requirements and limitations. It is the responsibility of the specifier to review local, state and regional codes to determine their impact on the specified Carlisle Roofing System.

NOTE: For code approvals achieved with the Carlisle Roofing Systems, refer to the Carlisle Code Approval Guide, Factory Mutual (FM) Approval Guide or Underwriters Laboratories (UL) Fire Resistance or Roofing Materials and Systems Directories.

- A. Carlisle recommends the use of Carlisle supplied products for use with these Carlisle Roofing Systems. The performance or integrity of products by others, **when selected by the specifier and accepted as compatible by Carlisle**, is not the responsibility of Carlisle and is **disclaimed** by the Carlisle Warranty.
- B. The specified roofing system must be installed by a Carlisle Authorized Roofing Applicator in compliance with drawings and specifications as approved by Carlisle SynTec.
- C. There must be no deviations made from Carlisle's specification or Carlisle's approved shop drawings without the **PRIOR WRITTEN APPROVAL** of Carlisle SynTec.
- D. After completion of the installation, upon request, an inspection shall be conducted by a Field Service Representative (FSR) of Carlisle SynTec to ascertain that the membrane roofing system has been installed according to Carlisle's published specifications and details applicable at the time of bid. This inspection is to determine whether a warranty shall be issued. It is not intended as a final inspection for the benefit of the owner.

1.04 Submittals

- A. To ensure compliance with Carlisle's minimum warranty requirements, the following projects should be forwarded to Carlisle for review prior to installation, preferably prior to bid:
 - 1. Canopies and buildings with large openings where the total wall openings exceed 10% of the total wall area on which the openings are located (such as airport hangars, warehouses and large maintenance facilities).
 - 2. Projects which incorporate purlin spacing other than 5' on center where a Mechanically Fastened membrane assembly is specified.
 - 3. Projects where the roofing membrane is expected to come in direct contact with petroleum-based products or other chemicals.
 - 4. Retrofit projects being refurbished for different usage.
- B. Along with the project submittals (shop drawings and Request for Warranty), the roofing contractor must include pullout tests when results are below the requirements identified in this specification.
- C. Shop drawings must be submitted to Carlisle by the Carlisle Authorized Roofing Applicator along with a completely executed Notice of Award (Page 1 of Carlisle's Request For Warranty form) for approval. Approved shop drawings are required for inspection of the roof and on projects where on-site technical assistance is requested.

Along with the project submittals (shop drawing and Request for Warranty), the roofing contractor must include pullout test results when the results are below the requirements identified in, Table included in Design Reference DR-06-11 "Withdrawal Resistance Criteria".

D. **Notice of Completion** (Page 2 of the Carlisle Request for Warranty form)

After project completion, a Notice of Completion must be submitted to Carlisle to schedule the necessary inspection of the project prior to issuance of the Carlisle Warranty.

1.05 Warranty

A. Membrane System Warranty is available for roofing systems on commercial buildings within the United States and applies only to **products manufactured or marketed by Carlisle SynTec**. The membrane system is defined as membrane, flashings, adhesives, sealants and other Carlisle brand products utilized in the installation. For a complete description of these products, refer to the Part II "Products" Section in this Specification and Spec Supplement "Related Products" P-01-11.

B. **See Table Below for information regarding Warranted Systems and Design Criteria:**

Years*	Metal Retrofit Thermoset (Sure-Seal/Sure-White) Membranes Warranty Options		
	Warranty Wind Speed Coverage		Minimum Membrane Thickness
	55, 72 or 80 MPH*	55, 72 and 80 MPH*	
	Adhered	Mechanically Fastened	
5,10, or 15 year	√	N/A	Sure-Seal /Sure-White 60-mil
	√	√	Sure-Tough 45-mil
	√	N/A	Sure-Seal/Sure-White FleeceBACK 100-mil
20 year	√	N/A	Sure-Seal/Sure-White 60-mil
	√	√	Sure-Tough 60-mil
	√	N/A	Sure-Seal/Sure-White FleeceBACK 115-mil

Notes: N/A = Not Acceptable √= Acceptable

*Contact Carlisle for recommended enhancements including additional perimeter sheets OR increased fastening density for increased warranty duration or wind speed coverage greater than 80 MPH.

1.06 Job Conditions

- A. Wood nailers are required for the securement of metal edgings, scuppers, and insulated pipes. Wood Nailer shall be secured per specifier recommendation or in accordance with FM Global's Property Loss Prevention Data Sheet 1-49. Refer to Design Reference DR-08-11 "Wood Nailers Securement Criteria" in Carlisle Technical Manual shall be referenced.
- B. When fastening to a structural purlin, a trial fastener should be installed when purlins are heavier than 12 gauge to determine the feasibility of the HP Purlin Fastener. HP Purlin Fasteners are designed to engage purlins 18 to 12 gauge.

REV 1/2014

- D. Due to the wide variety of edge conditions found in metal buildings, edge details may be submitted to Carlisle for review preferably prior to installation.
- E. Fiberglass insulation is not physically compatible with this roofing system and cannot be utilized over the existing metal roof (even when specified in multiple layer applications in conjunction with an acceptable underlayment).

1.07 Product Delivery, Storage and Handling

- A. Deliver materials to the job site in the original, unopened containers.
- B. When loading materials onto the roof, the Carlisle Authorized Roofing Applicator must be comply with the requirements of the specifier/owner to prevent overloading and possible disturbance to the building structure.
- C. Job site storage temperatures in excess of 90° F (32° C) may affect shelf life of curable materials (i.e. adhesives and sealants).
- D. **When the temperature is expected to fall below 40° F (5° C)**, outside storage boxes should be provided on the roof for temporary storage of liquid adhesives and sealants. Adhesives and sealant containers should be rotated to maintain their temperature above 40° F (5° C).
- E. Insulation/underlayment must be stored so that it is kept dry and is protected from the elements. Store insulation on a skid and completely cover with a breathable material such as tarp or canvas. If the insulation is lightweight, it should be weighted to prevent possible wind damage.

PART II – PRODUCTS

2.01 General

The components of this roofing system are to be products of Carlisle or accepted by Carlisle as compatible. The installation, performance or integrity of products by others, **when selected by the specifier and accepted by Carlisle**, is not the responsibility of Carlisle and is expressly disclaimed by the Carlisle warranty.

2.02 Membrane/Related Products

A. Membranes

1. For **Mechanically Fastened membrane assemblies**, any of the membranes listed below may be utilized.

Sure-Tough (black) 45-mil, 60-mil or 75-mil thick reinforced EPDM (Ethylene, Propylene, Diene Terpolymer) membrane is available in widths up to 10 feet wide.

2. For **Adhered Membrane Assemblies**, any of the membranes listed below may be utilized.

- a. **Sure-Seal/Sure-White** 60 or 90-mil thick non-reinforced EPDM (Ethylene, Propylene, Diene Terpolymer) membrane is available in various widths, refer to EPDM Specification for additional information.

- b. **Sure-Tough** (black) 45-mil, 60-mil or 75-mil thick reinforced EPDM (Ethylene, Propylene, Diene Terpolymer) membrane is available in widths up to 10 feet wide.

- c. **Sure-Seal/Sure-White** 105, 115, or 145-mil FleeceBACK membrane is available in various widths of 5 or 10 feet wide.

For membrane physical properties and other related products, refer to the appropriate "Products" Section of the appropriate membrane specification.

B. Related Products

1. **Carlisle EPS (Flute-Filler):** A custom-made, high performance insulation consisting of a superior closed-cell, lightweight expanded polystyrene (EPS) that meets the requirements of ASTM C578. The product offers a long-term, stable R-Value and has excellent dimensional stability, compressive strength and water resistant properties. It is custom-manufactured for each specific application, and is readily available in a variety of lengths, widths and shapes to meet virtually any job condition.
2. **Carlisle H-Shield Polyisocyanurate (Flute-Filler):** A custom-cut insulation consisting of a closed-cell polyisocyanurate that meets the requirements of ASTM D2126. It is custom-cut for each specific application, and is readily available in a variety of lengths and widths.
3. **SecurShield HD:** A rigid roof insulation panel composed of a high-density, closed-cell polyisocyanurate foam core laminated to a premium-performance, coated-glass fiber-mat facer specifically designed for use as a cover board.
4. **SecurShield CD (Combustible Deck):** A rigid roof insulation panel composed of a closed-cell polyisocyanurate foam core manufactured on-line to an extra durable, dimensionally stable coated-glass facer on each surface side for use as a cover board. Achieves a UL Class A combustible deck assembly rating at a 1" thickness without the use of a fire-rated slip sheet or gypsum coverboard.
5. **HP Purlin Fastener:** A hex-head, threaded, self-drilling, black epoxy electro-deposition coated (E-Coat) fastener used for membrane/RUSS securement into structural purlins (12-18 gauge) in conjunction with Sure-Tough Metal Retrofit Roofing Systems.
6. **HP Fastener:** A threaded E-coat square head fastener used for insulation and additional membrane attachment (Adhered Roofing Systems) in conjunction with 2" diameter polymer plates.
7. **HP-X Fastener:** A heavy duty #15 threaded fastener with a #3 Phillips drive used with Carlisle's Piranha™ Fastening Plate to secure Mechanically Fastened Roofing Systems.
8. **Insulation Fastening Plates:** A nominal 3" diameter metal plate used for insulation attachment in conjunction with the appropriate Carlisle Fastener.
9. **Seam Fastening Plates:** A 2" diameter metal plate used for insulation attachment on Mechanically Fastened Roofing Systems or membrane securement on Adhered Roofing Systems in conjunction with the appropriate Carlisle Fastener.
10. **HP Polymer Seam Plate:** A 2" diameter plastic barbed fastening plate used with Carlisle HP Purlin Fasteners for membrane and Pressure-Sensitive RUSS securement into the structural purlins for Sure-Tough Mechanically Fastened Roofing Systems. This plate can also be used for securement of insulation/membrane underlayment in mechanically fastened assemblies.
11. **Piranha Plate:** A 2-3/8" diameter metal barbed fastening plate used primarily for membrane securement in conjunction with HP Purlin Fasteners. The plate is also used in conjunction with appropriate fasteners for securement of insulation/membrane underlayments in mechanically fastened assemblies.
12. **9" wide Pressure-Sensitive RUSS:** Utilized for perimeter membrane securement on Sure-Tough Mechanically Fastened Roofing Systems and primary securement on Metal Retrofit Roofing Systems.

For membrane physical properties and other related products, refer to the appropriate “Products” Section of the appropriate membrane specification.

PART III – EXECUTION

3.01 General

In addition to the criteria contained herein, refer to the specific roof membrane Specification contained in the Carlisle Technical Manual for additional information.

3.02 Existing Metal Roof Criteria

- A. Defects in the existing metal roof or purlin system must be reported and documented to the specifier, general contractor and building owner for assessment. The Carlisle Authorized Roofing Applicator shall not proceed unless the defects are corrected.
- B. The following chart identifies the minimum pullout values which must be achieved with both the HP Purlin Fastener, which is required for RUSS/membrane securement, and the HP or HP-X Fastener, which is required for additional membrane securement around penetrations (i.e. vent pipes) and is recommended for insulation securement:

Purlins		Metal Roofs	
Gauges	HP Purlin Fastener Min. Pullouts (lbs./fastener)	Gauges	HP or HP-X Fastener Min. Pullouts (lbs./fastener)
12	1,000	24	300
14	1,000	26	200
16	800	28*	150
18	600		

* Pullouts must be submitted to Carlisle when an Adhered Assembly is to be selected.

Withdrawal resistance tests are strongly suggested to determine the suitability of the existing metal roof and structural purlins for the application of this roofing system.

CAUTION: Visually inspect existing metal roof and conduct pullout tests at low areas (i.e. eaves and valleys) or areas of concern during visual inspection.

3.03 Substrate Preparation

- A. Clear the substrate of debris and foreign material.
- B. Wood nailers are required at all roof edges where metal edging and gutter systems are specified and must be flush with the top of the specified membrane underlayment.

When treated lumber is specified, it is recommended that only lumber that has been pressure treated with salt preservatives be specified. Lumber treated with other wood preservatives such as, Creosote, Pentachlorophenol, Copper Naphthenate, Copper 8-quinolinolate, will adversely affect the membrane when in direct contact and are, therefore, unacceptable.

- C. On standing seam metal roofs, two layers of wood nailers are required with the first layer installed between the raised standing seams, flush with the top surface of the seams. These nailers must be mechanically fastened directly to the structural purlins with Sure-Seal HP Purlin Fasteners spaced a maximum of 16 inches on center. Sections of wood nailers installed between standing seams must have a minimum of 2 fasteners positioned approximately 3 inches from each end of the nailer (spaced no more than 16 inches apart).

The top layer of wood nailers is then fastened to the bottom layer of wood nailers with Sure-Seal HP or HP-X Fasteners spaced a maximum of 16 inches on center with all fasteners penetrating the bottom layer of wood nailers a minimum of 1 inch.

Note: In lieu of Sure-Seal Fasteners, galvanized or coated nails may be used to secure the top nailer when positioned 4 inches on center and staggered 3/4 inch on center. The nails shall be sufficient in length to penetrate the bottom nailer a minimum of 1-1/4 inch.

- D. On corrugated metal roofs, batt insulation or other compressible filler must be used beneath perimeter wood nailers to minimize infiltration of air beneath this roofing system.
- E. On flat seam metal roofs, the underside of the wood nailer should be notched at the flat seam areas to achieve a smooth, stable base.

Note: The existing metal roof may be trimmed at metal edge and gutter locations to minimize the dimension between the edge purlin support and the edge of the metal roof. This will allow standard size nailers (2" x 6") to be fastened to the edge purlin flush with the roof edge.

3.04 Installation

A. Insulation Placement and Attachment

1. Membrane underlayment must be butted together with no gaps greater than 1/4 inch. Gaps greater than 1/4 inch are not acceptable.
2. On standing seam metal roofs, insulation must be installed in multiple layers. The first layer of insulation is used as a fill between standing seams, relatively flush with the top surface of the seams. A second layer of insulation is placed over the first layer and the standing seams to serve as the membrane underlayment.
3. When mechanical fasteners are specified for insulation securement, the bottom layer (fill boards) can be loose laid with the top layer (membrane underlayment) mechanically fastened to the metal roof at the rate of 1 fastener per 4 square feet for Mechanically Fastened Systems.
4. When mechanical fasteners are specified for insulation securement, the bottom layer (fill boards) can be loose laid with the top layer (membrane underlayment) mechanically fastened to the metal roof at the rate of 1 fastener per 2 square feet for Adhered Systems.
5. When insulation is to be attached with FAST Adhesive or FAST Dual Cartridges, both the bottom and top layers must be adhered in accordance with installation procedures outlined in the Spec Supplement G-03-11 FAST Adhesive Application/Coverage Rate in the Carlisle Technical Manual.

Note: Two-part urethane adhesives may not be compatible with certain types of metal roof coatings. If existing, Carlisle should be contacted for verification. Mechanical fasteners may be specified in lieu of the adhesive providing the minimum pullouts can be met.

B. Membrane Installation

1. Sure-Tough Mechanically Fastened Roofing Systems

- a. Securement for this roofing system is accomplished by splicing the membrane to the Pressure-Sensitive RUSS (9 inch wide) that is positioned along the structural purlins and spaced 5 feet or 10 feet on center depending on project wind zone. The RUSS is attached to the purlins a maximum of 12 inches on center utilizing Sure-Seal HP Purlin Fasteners and Polymer Seam Plates. Refer to appropriate Carlisle Details.
- b. Securement of the membrane at the perimeter roof areas shall be achieved by attaching the membrane to the RUSS positioned along the first purlin from the roof edge/eave (perpendicular to the roof slope). Along the rake edges, membrane securement is achieved with RUSS positioned along all purlins for a distance of no less than 5 feet. Refer to appropriate Carlisle Details for required fastening density according to project wind zone.
- c. When using Pressure-Sensitive RUSS, EPDM primer must be applied to the membrane in accordance with standard procedures.
- d. Install consecutive membrane sheets allowing a minimum overlap onto the adjacent membrane sheets following respective membrane application requirements.
- e. For additional information pertaining to membrane splicing, refer to the appropriate Membrane Specification in the Carlisle Technical Manual.
- f. Additional membrane securement must be provided at the perimeter of each roof level, roof section, expansion joint, curb flashing, skylight, interior wall, penthouse, etc., at any inside angle change where slope exceeds 2" in one horizontal foot, and at other penetrations in accordance with Carlisle's details and securement options.

2. Sure-Seal/Sure-White, Sure-Tough, or Sure-Seal/Sure-White FleeceBACK Adhered Roofing Systems

For installation procedures on Adhered Roofing Systems, refer to appropriate Membrane Specification in the Carlisle Technical Manual.

C. Other Related Work

Refer to appropriate Membrane Specification in the Carlisle Technical Manual for additional membrane securement, membrane flashing and other related clean up work.

Copyright 2012 Carlisle SynTec Systems

Carlisle, Sure-Seal, Sure-White, FleeceBACK, Sure-Tough and SecurTAPE
are trademarks of Carlisle SynTec Systems

Carlisle SynTec Systems
P.O. Box 7000
Carlisle, PA 17013
800-479-6832

<http://www.carlisle-syntec.com>

METAL RETROFIT

Sure-Seal®/Sure-White® Sure-Tough™ EPDM Metal Retrofit Roofing Systems

Installation Details

TABLE OF CONTENTS

July 2013

Metal Edges and Gutters	Details
Eave / Rake Edge	E1.1A
Eave / Rake Edge	E1.1B
Eave / Rake Edge – Heavy Gauge Fascia	E1.2
Gutter With Fascia.....	E1.3
Gutter Without Fascia.....	E1.4
Gutter With Straps Anchored into Standing Seams	E1.5
Gutter With Straps Anchored into Standing Seams	E1.6
High End Vented Roof Edge	E1.7
Rake Edge	E1.8
Rake Edge	E1.9
Membrane Attachment	
Membrane Attachment with RUSS.....	E2.1
Membrane Attachment - Up to 100 MPH Wind Zone	E2.2
Membrane Attachment - 101 - 120 MPH Wind Zone	E2.3
Roof Perimeter Zones	E2.4
Expansion Joints	
Expansion Joint at Step Down Condition.....	E3.1
Vertical Wall	
Vertical Wall – Vented Base Detail.....	E12.1
Ridges	
Roof Ridge/Hip - Non-Vented.....	E22.1
Roof Ridge - Vented.....	E22.2
Common Details	
Enlarged Details.....	Z1.1
ANSI/SPRI ES-1 Compliant Fascia – Shop Fabricated.....	Z1.2

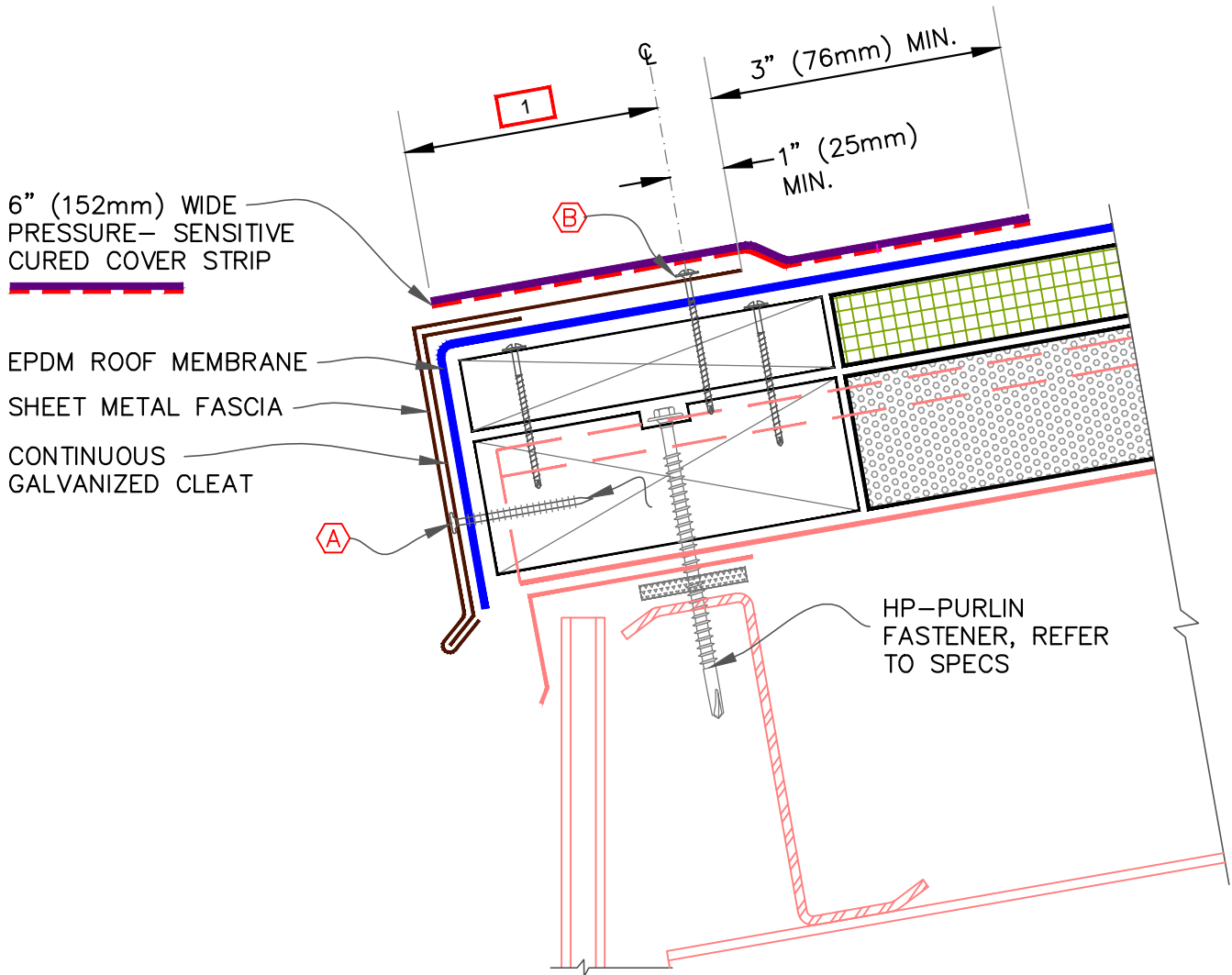

NOTE:

1. FASCIA HORIZONTAL FLANGE MUST BE TOTALLY COVERED WITH CURED EPDM FLASHING, MINIMUM 2" (51mm) BEYOND THE FASTENER HEAD.

A 1-1/2" (38mm) RING SHANK NAILS @ 6" (152mm) O.C. MAXIMUM



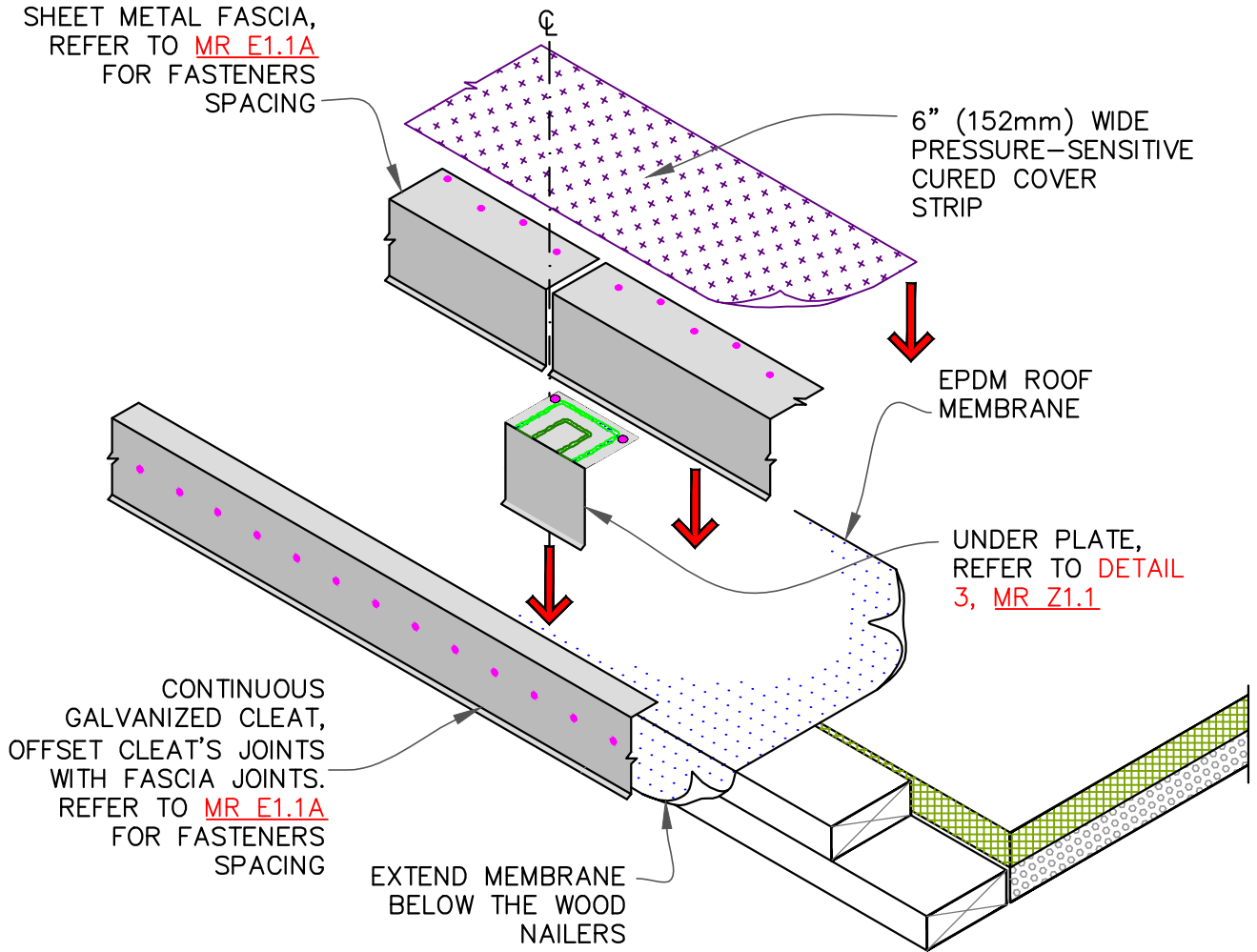

B HP FASTENERS @ 12" (305mm) O.C. OR RING-SHANK NAILS @ 4" (102mm) O.C. & STAGGERED 3/4" (19mm) O.C.

EAVE / RAKE EDGE			SHEET NO.
• HIGH DENSITY RECOVER BOARD	• ROOF MEMBRANE		MR E1.1A
• IN-FILL INSULATION	• WOOD NAILER (BY OTHERS)	PAGE 1 OF 2	
0 • SEE DRAWING NOTE(S)			



NOTE:

REFER TO [MR Z1.1](#) & [MR Z1.2](#) AT THE END OF THIS SECTION.

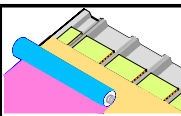
EAVE / RAKE EDGE		SHEET NO.	
	• HIGH DENSITY RECOVER BOARD		• ROOF MEMBRANE
	• IN-FILL INSULATION		• WOOD NAILER (BY OTHERS)
			• SEE DRAWING NOTE(S)
			MR E1.1B
		PAGE 2 OF 2	

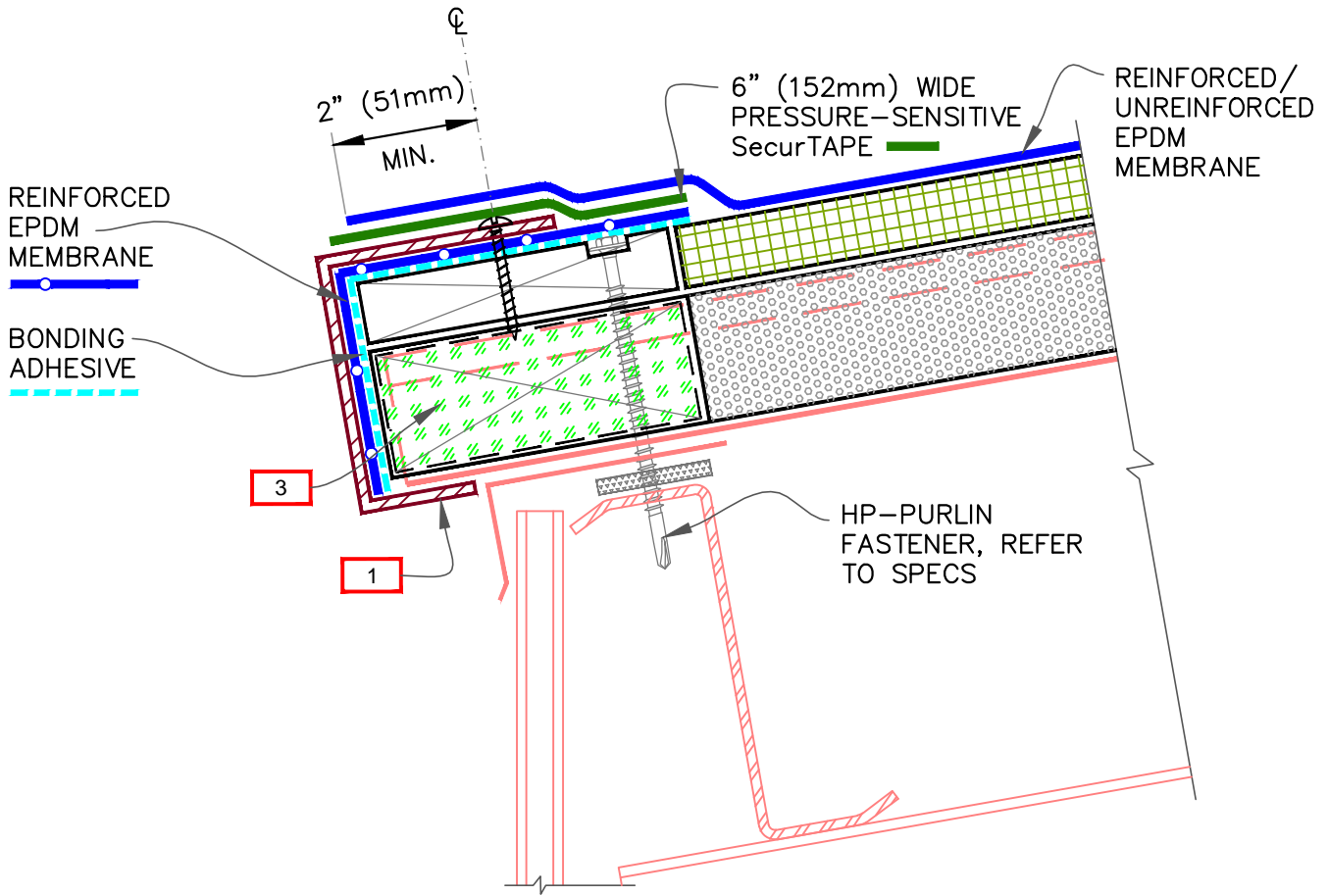



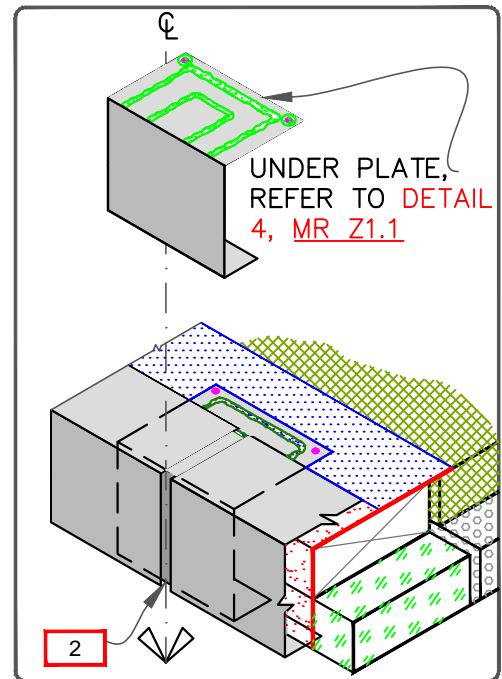

NOTES:

1. 18-GAUGE, C-CHANNEL PRE-PUNCHED AND CUSTOM FORMED TO FIT SPECIFIED PROJECT REQUIREMENTS. SECURED TO WOOD BLOCKING, FASTEN WITH HP-FASTENERS @ 12" (305mm) O.C.
2. ALLOW 1/4" (6mm) MIN. TO 1/2" (13mm) MAX. SPACING BETWEEN CONSECUTIVE LENGTH OF C-CHANNELS. AT CORNERS, CUT C-CHANNEL TO PROVIDE MITERED JOINTS.
3. INSULATION WITH GREATER COMPRESSIVE STRENGTH OR WOOD BLOCKING.
4. REFER TO [MR Z1.1](#) & [MR Z1.2](#) AT THE END OF THIS SECTION.

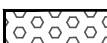

EAVE / RAKE EDGE - HEAVY GAUGE FASCIA

 • HIGH DENSITY RECOVER BOARD	 • ROOF MEMBRANE
 • IN-FILL INSULATION	 • WOOD NAILER (BY OTHERS)
	• SEE DRAWING NOTE(S)

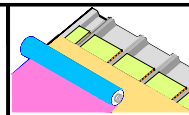

SHEET NO.
MR | E1.2

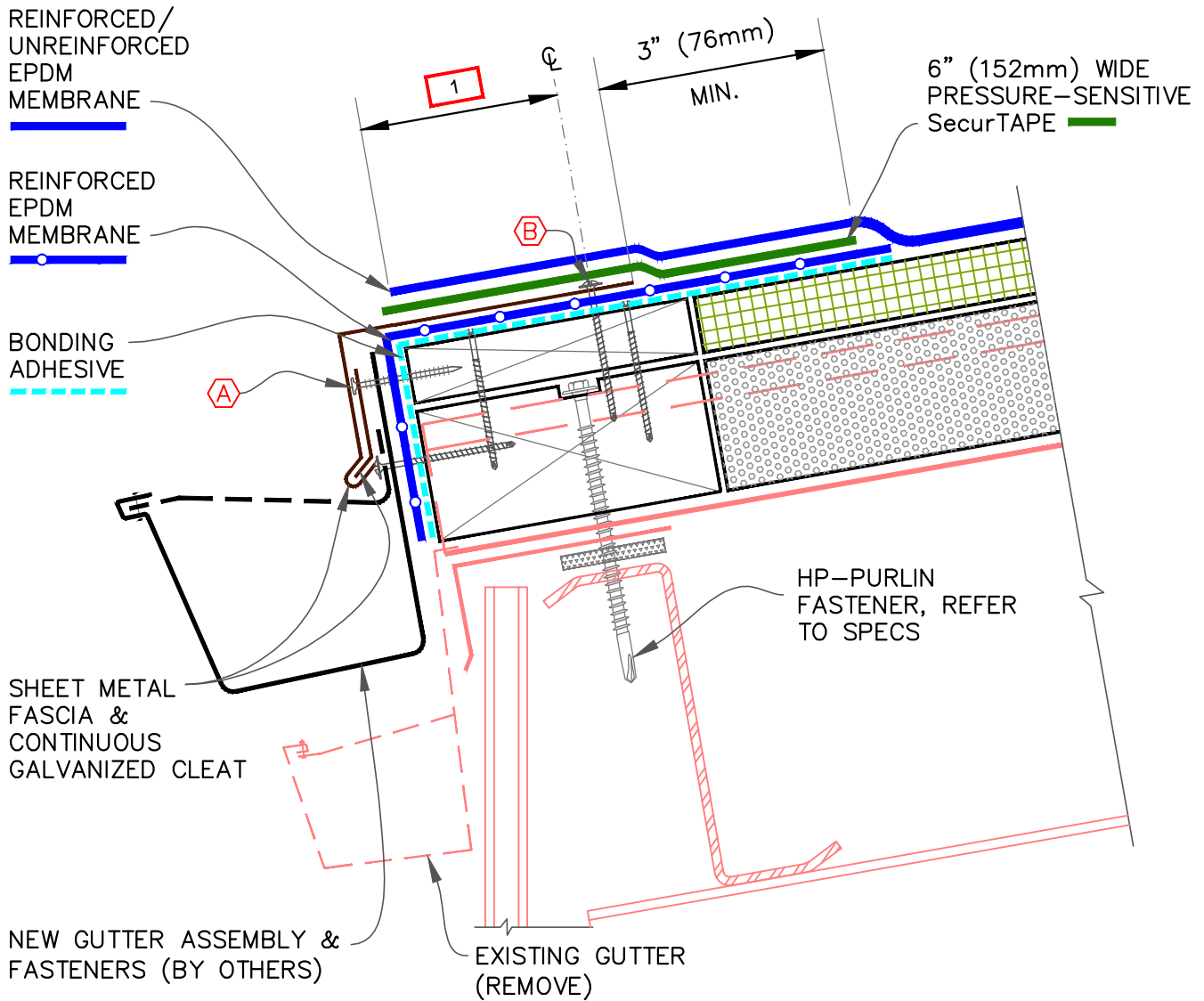





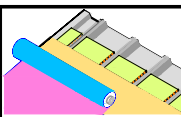

NOTES:

1. FASCIA HORIZONTAL FLANGE MUST BE TOTALLY COVERED, MINIMUM 2" (51mm) BEYOND THE NAIL.
2. REFER TO [MR Z1.1](#) & [MR Z1.2](#) AT THE END OF THIS SECTION.

A 1-1/2" (38mm) RING SHANK NAILS @ 6" (152mm) O.C. MAXIMUM

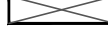
B HP FASTENERS @ 12" (305mm) O.C. OR RING-SHANK NAILS @ 4" (102mm) O.C. & STAGGERED 3/4" (19mm) O.C.

GUTTER WITH FASCIA			SHEET NO.
 HIGH DENSITY RECOVER BOARD	 ROOF MEMBRANE		MR
 IN-FILL INSULATION	 WOOD NAILER (BY OTHERS)		
  SEE DRAWING NOTE(S)			

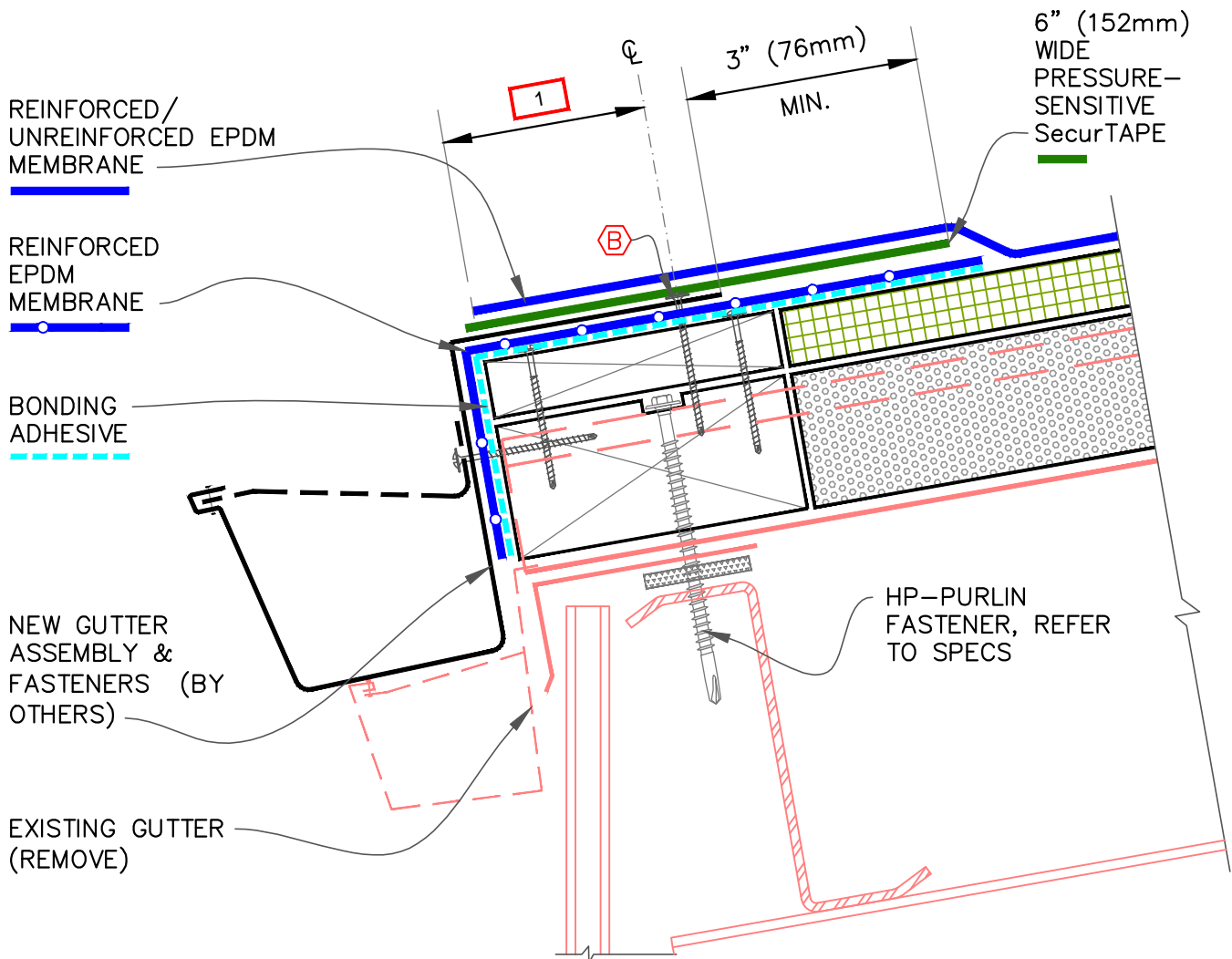

NOTES:

1. FASCIA HORIZONTAL FLANGE MUST BE TOTALLY COVERED, MINIMUM 2" (51mm) BEYOND THE FASTENER HEAD.
2. REFER TO [MR Z1.1](#) & [MR Z1.2](#) AT THE END OF THIS SECTION.

B HP FASTENERS @ 12" (305mm) O.C.
OR RING-SHANK NAILS @ 4" (102mm) O.C. & STAGGERED 3/4" (19mm) O.C.

GUTTER WITHOUT FASCIA		SHEET NO.	
• HIGH DENSITY RECOVER BOARD	• ROOF MEMBRANE		MR E1.4
• IN-FILL INSULATION	• WOOD NAILER (BY OTHERS)		
0	• SEE DRAWING NOTE(S)		

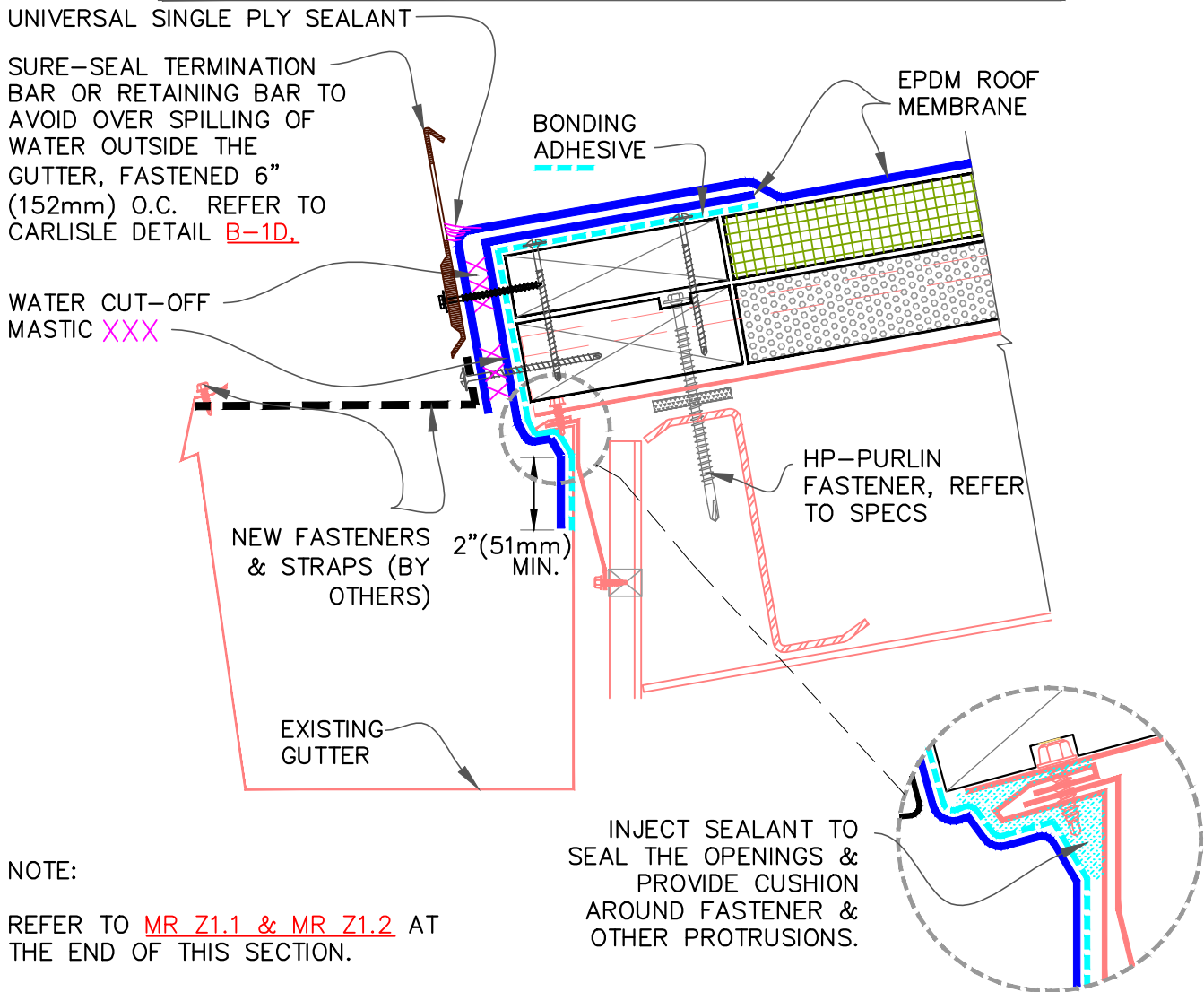
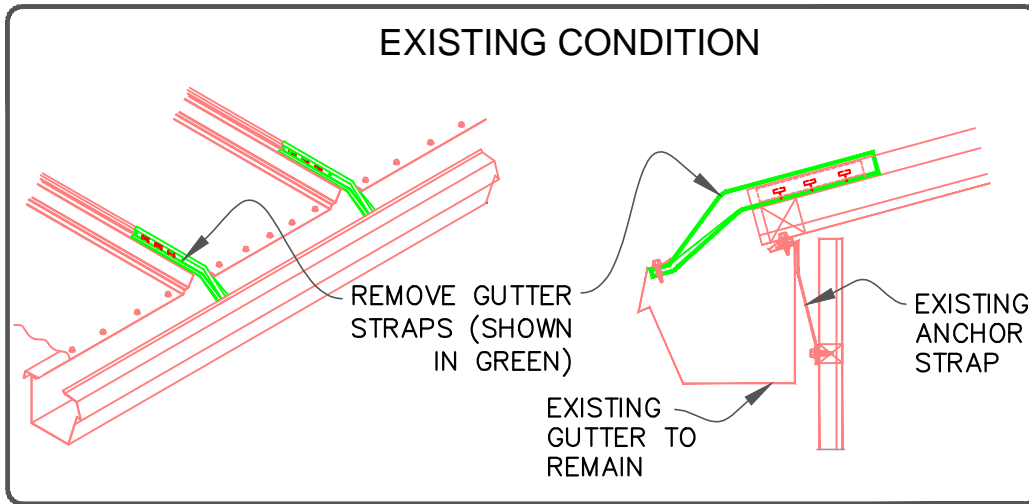

NOTE:

REFER TO [MR Z1.1](#) & [MR Z1.2](#) AT THE END OF THIS SECTION.

INJECT SEALANT TO SEAL THE OPENINGS & PROVIDE CUSHION AROUND FASTENER & OTHER PROTRUSIONS.

GUTTER WITH STRAPS ANCHORED INTO STANDING SEAMS		
<p> • HIGH DENSITY RECOVER BOARD</p> <p> • ROOF MEMBRANE</p> <p> • IN-FILL INSULATION</p> <p> • WOOD NAILER (BY OTHERS)</p> <p> • SEE DRAWING NOTE(S)</p>	<p></p>	<p>SHEET NO.</p> <p style="font-size: 24pt; font-weight: bold; color: blue;">MR E1.5</p>

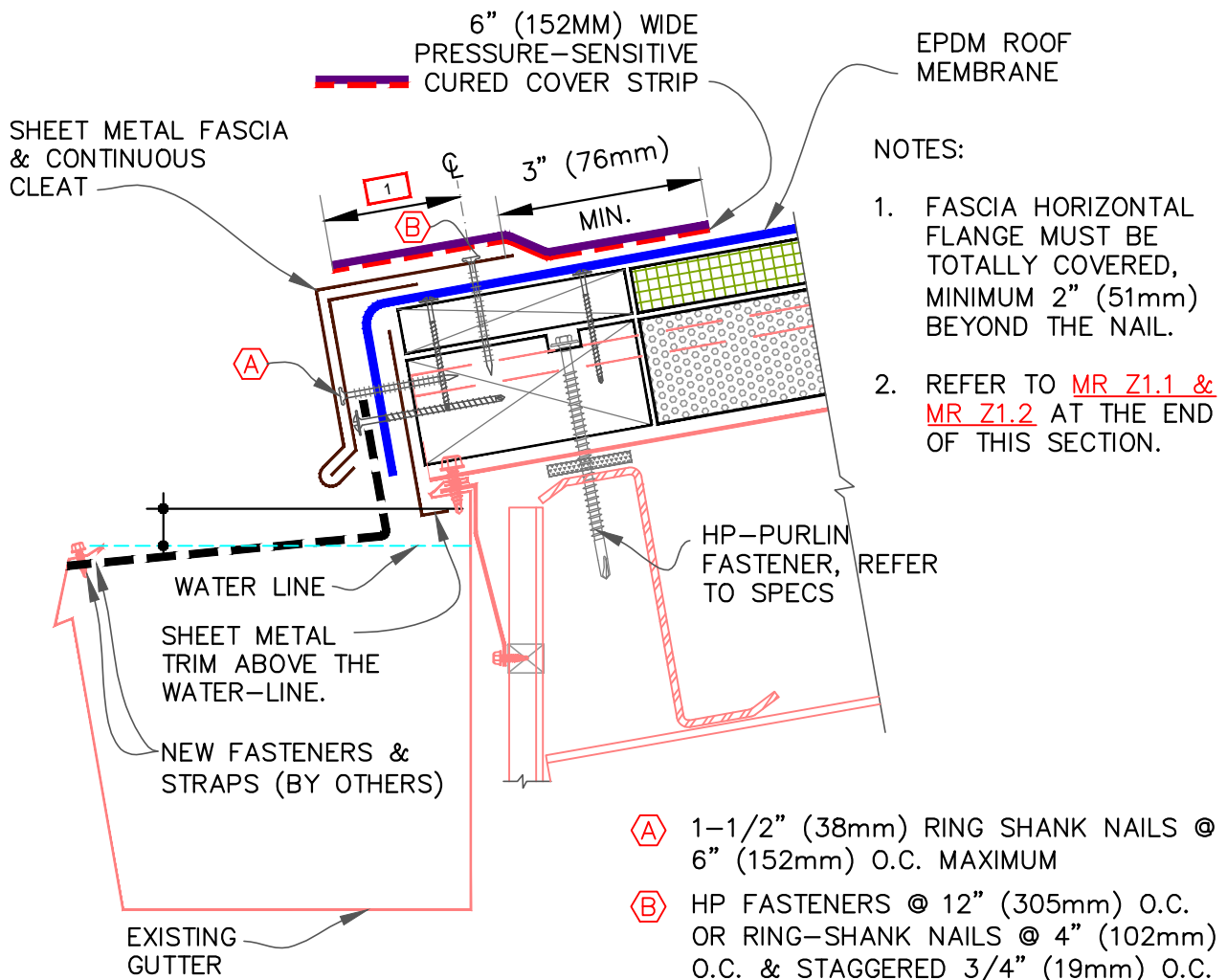
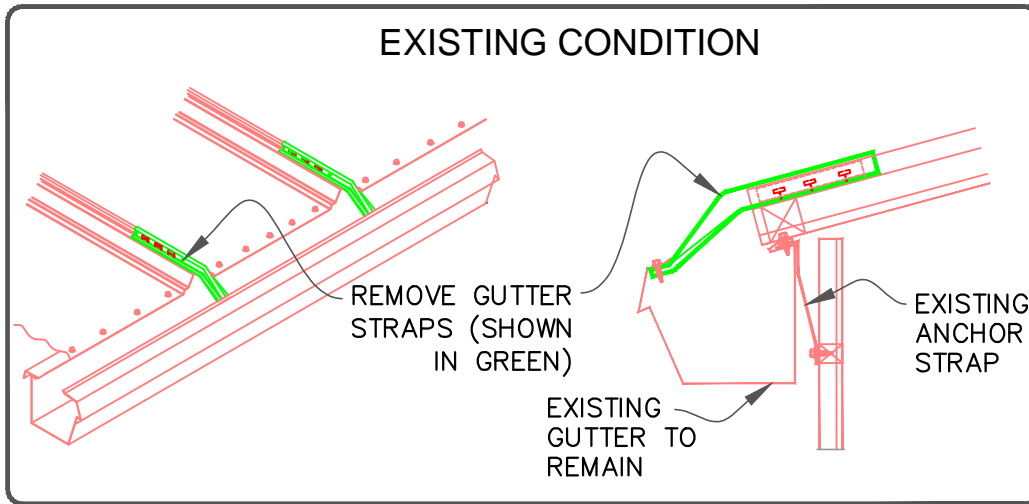

GUTTER WITH STRAPS ANCHORED INTO STANDING SEAMS

- HIGH DENSITY RECOVER BOARD
- ROOF MEMBRANE
- WOOD NAILER (BY OTHERS)
- IN-FILL INSULATION
- SEE DRAWING NOTE(S)

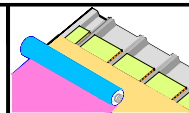

SHEET NO.
MR | E1.6

- (C) SHEET METAL SCREWS @ 6" O.C., MAX., EXPOSED 3/4" (19mm) MIN. BEYOND EXISTING SHEET METAL SUBSTRATE
- (D) FASTENERS TO MATCH EXISTING @ 6" O.C., MAX., EXPOSED 3/4" (19mm) MIN. BEYOND EXISTING SUBSTRATE

EXISTING HIGH-END VENTED ROOF EDGE

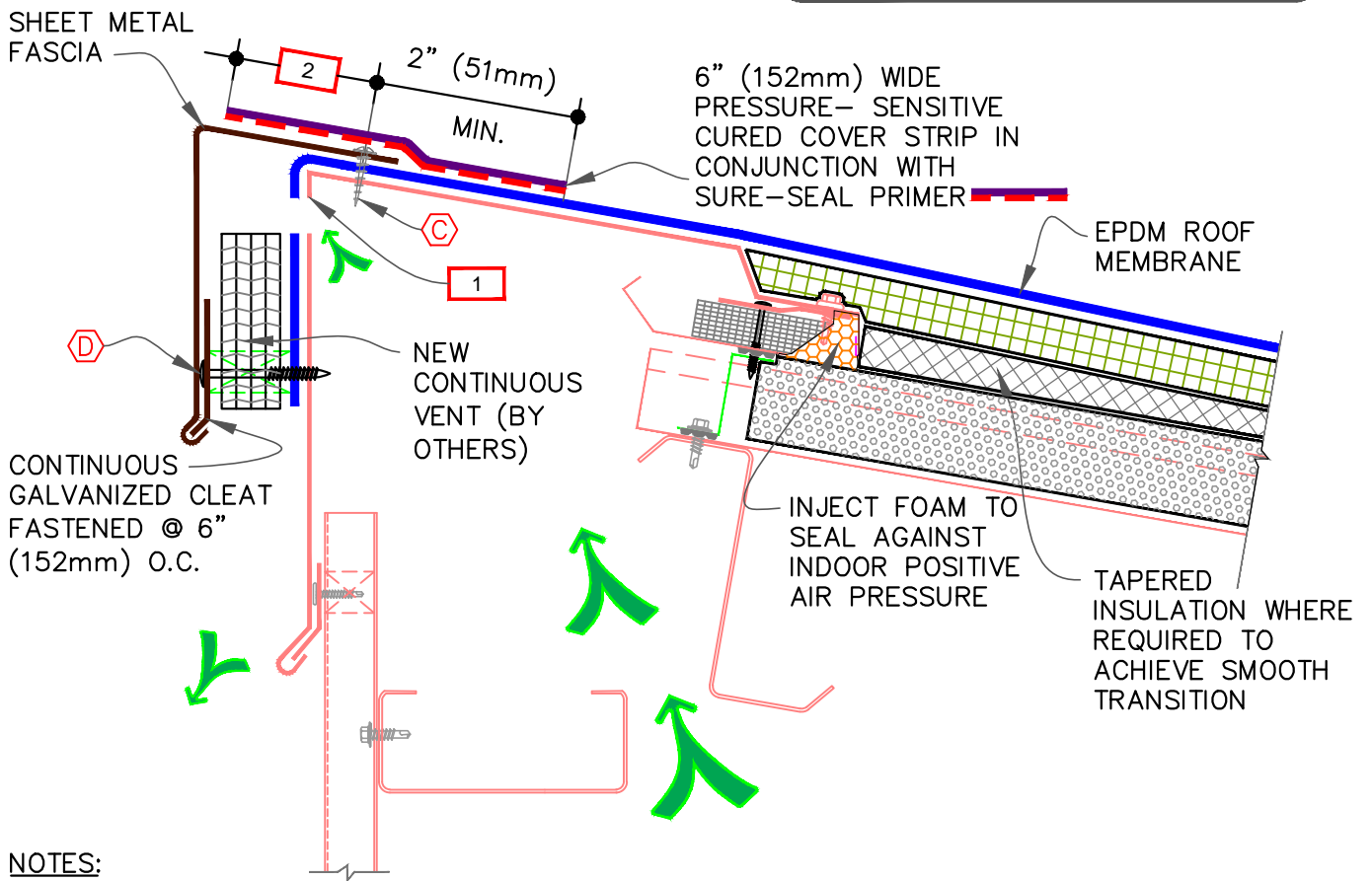
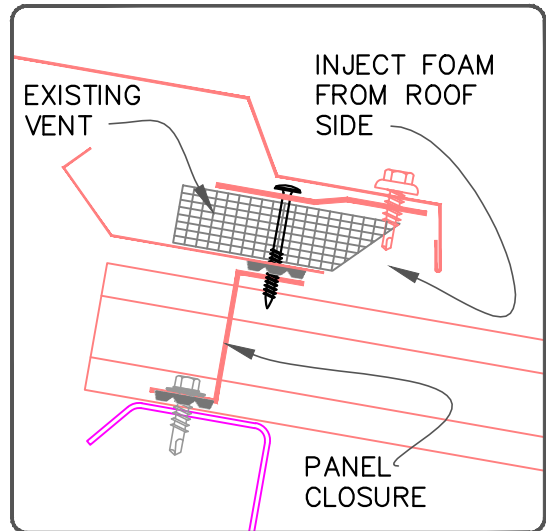

NOTES:

1. CUT HOLES IN EXISTING HIGH EAVE TRIM AT TOP TO REDIRECT VENTING. DESIGNER TO CALCULATE THE SIZES, FREQUENCY OF HOLES WITHOUT WEAKENING THE SHEET METAL.
2. DECK FLANGE MUST BE TOTALLY COVERED BY PRESSURE-SENSITIVE CURED COVER STRIP, MINIMUM 2" (51mm) COVERAGE PAST FASTENER HEAD.

HIGH-END VENTED ROOF EDGE		SHEET NO.	
• HIGH DENSITY RECOVER BOARD	• ROOF MEMBRANE		MR E1.7
• IN-FILL INSULATION	• WOOD NAILER (BY OTHERS)		
• SEE DRAWING NOTE(S)			

NOTES:

1. FASCIA HORIZONTAL FLANGE MUST BE TOTALLY COVERED MINIMUM 2" (51mm) BEYOND THE NAIL.
2. REFER TO [MR Z1.1](#) & [MR Z1.2](#) AT THE END OF THIS SECTION.

EXISTING FIXED (NON-FLOATING) RAKE TO REMAIN

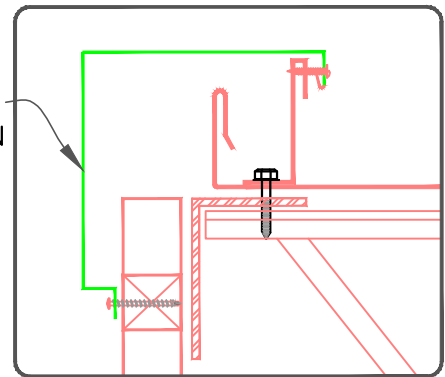

EXISTING FIXED RAKE EDGE

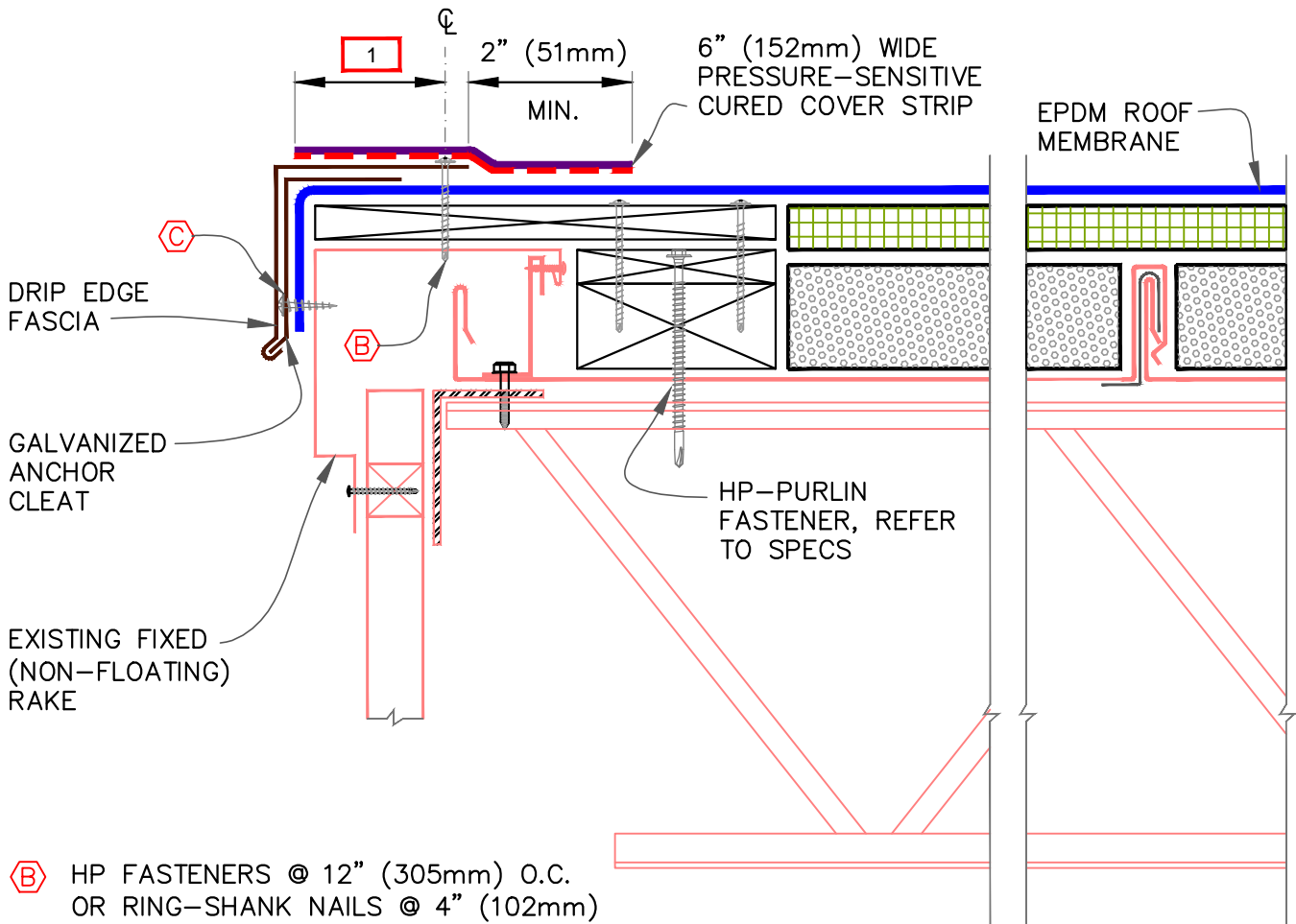

- B** HP FASTENERS @ 12" (305mm) O.C. OR RING-SHANK NAILS @ 4" (102mm) O.C. & STAGGERED 3/4" (19mm) O.C.
- C** SHEET METAL SCREWS @ 6" O.C., MAX., EXPOSED 3/4" (19mm) MIN. BEYOND EXISTING SHEET METAL SUBSTRATE

RAKE EDGE		SHEET NO.	
HIGH DENSITY RECOVER BOARD	ROOF MEMBRANE		MR E1.8
IN-FILL INSULATION	WOOD NAILER (BY OTHERS)		
SEE DRAWING NOTE(S)			

- ⓑ HP FASTENERS @ 12" (305mm) O.C.
OR RING-SHANK NAILS @ 4" (102mm) O.C. & STAGGERED 3/4" (19mm) O.C. RAKE AND CLIP REMOVED
- ⓓ FASTENERS TO MATCH EXISTING @ 6" O.C., MAX., EXPOSED 3/4" (19mm) MIN. BEYOND EXISTING SUBSTRATE

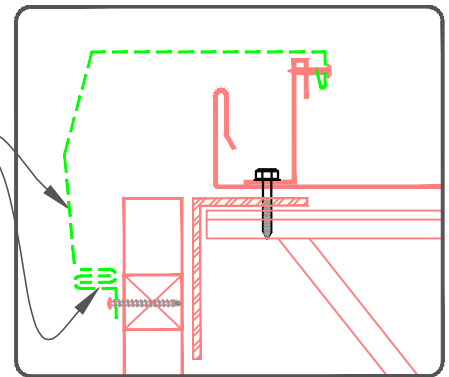

EXISTING FLOATING RAKE EDGE

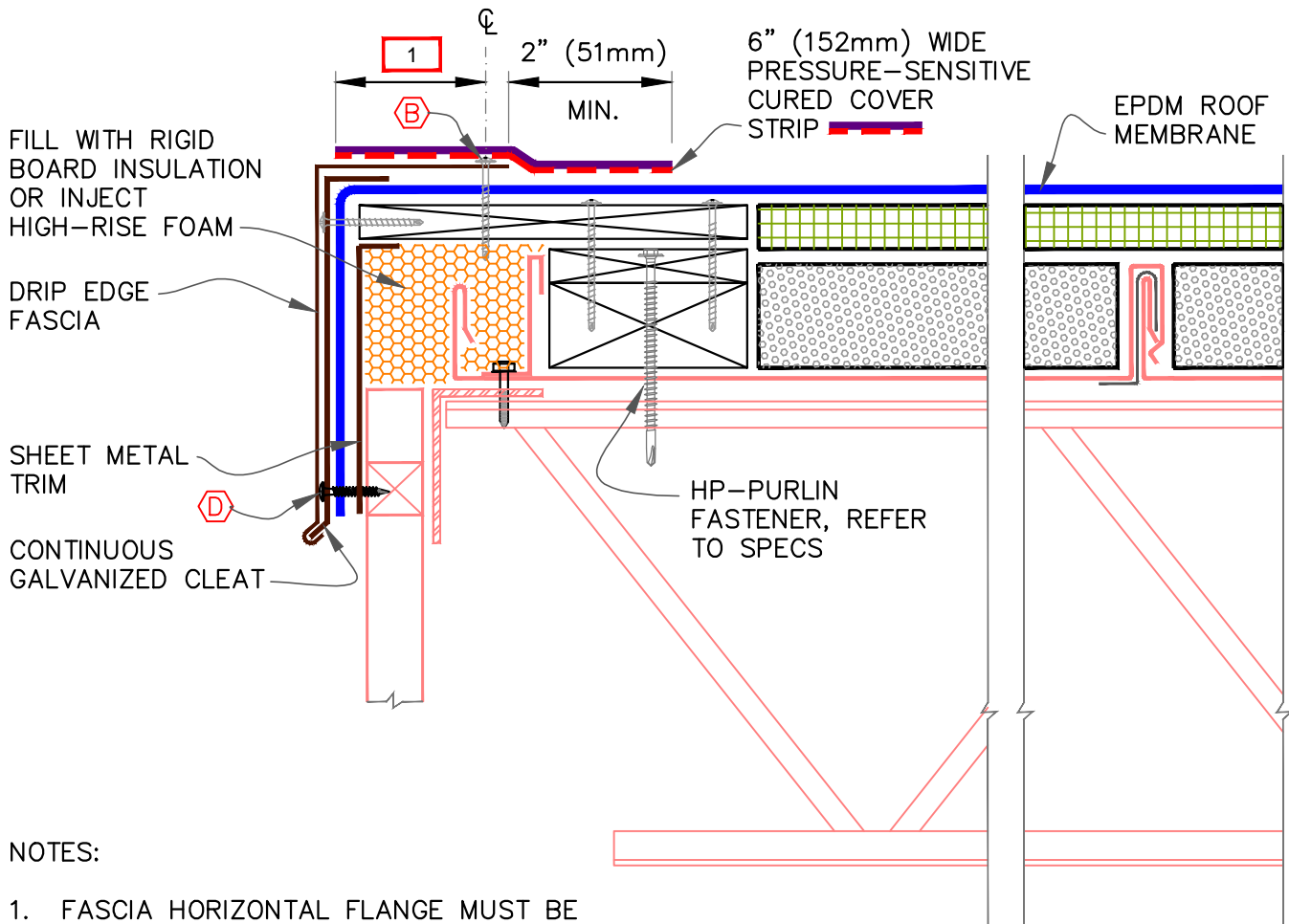



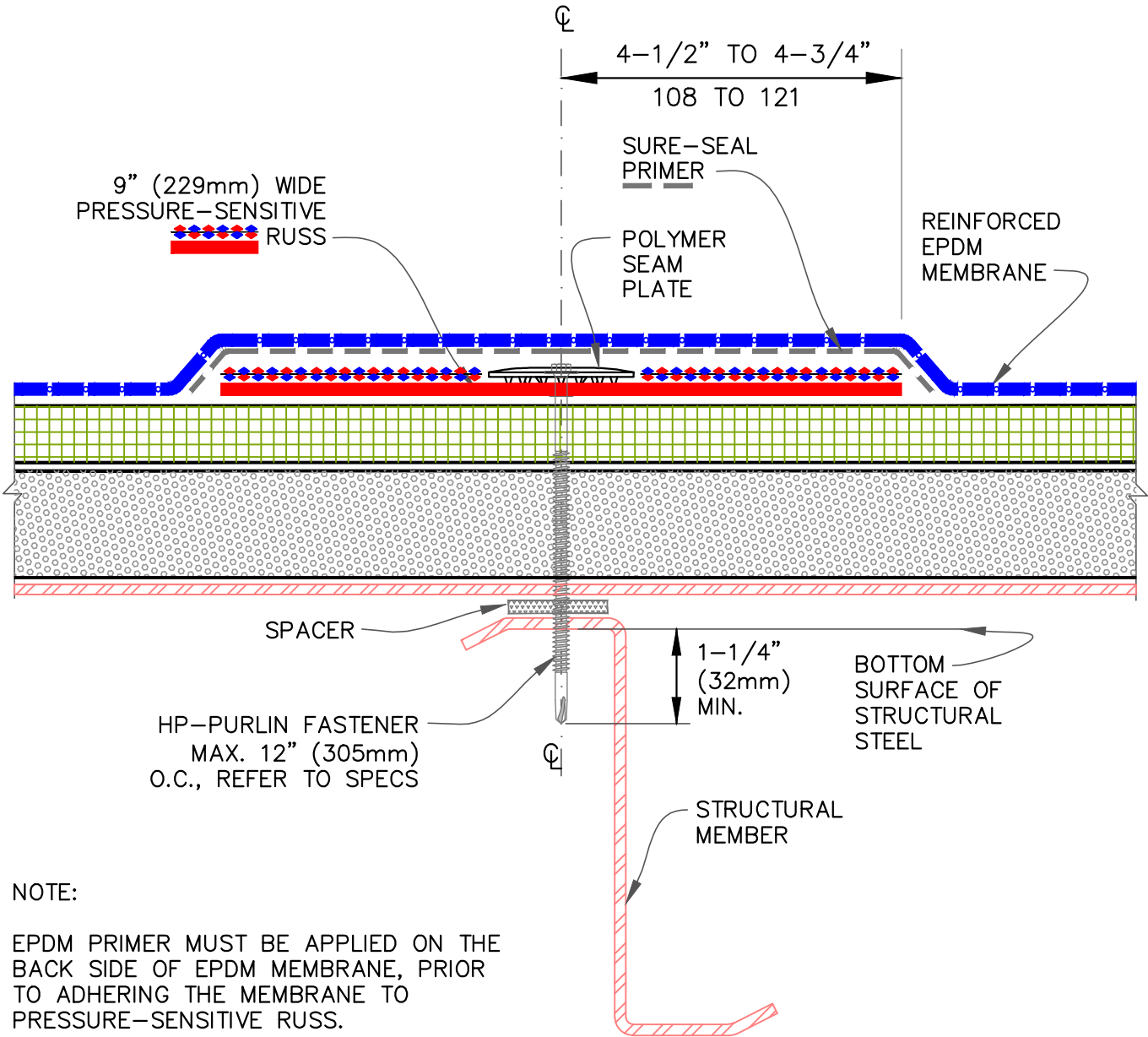

NOTES:

1. FASCIA HORIZONTAL FLANGE MUST BE TOTALLY COVERED MINIMUM 2" (51mm) BEYOND THE NAIL.
2. REFER TO [MR Z1.1](#) & [MR Z1.2](#) AT THE END OF THIS SECTION.

RAKE EDGE		SHEET NO.	
• HIGH DENSITY RECOVER BOARD	• ROOF MEMBRANE	• WOOD NAILER (BY OTHERS)	MR E1.9
• IN-FILL INSULATION	ⓐ 0 • SEE DRAWING NOTE(S)		

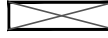

MEMBRANE ATTACHMENT WITH R.U.S.S

-  • HIGH DENSITY RECOVER BOARD
-  • ROOF MEMBRANE
-  • WOOD NAILER (BY OTHERS)
-  • IN-FILL INSULATION
-  • SEE DRAWING NOTE(S)

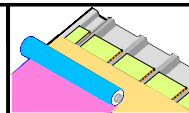



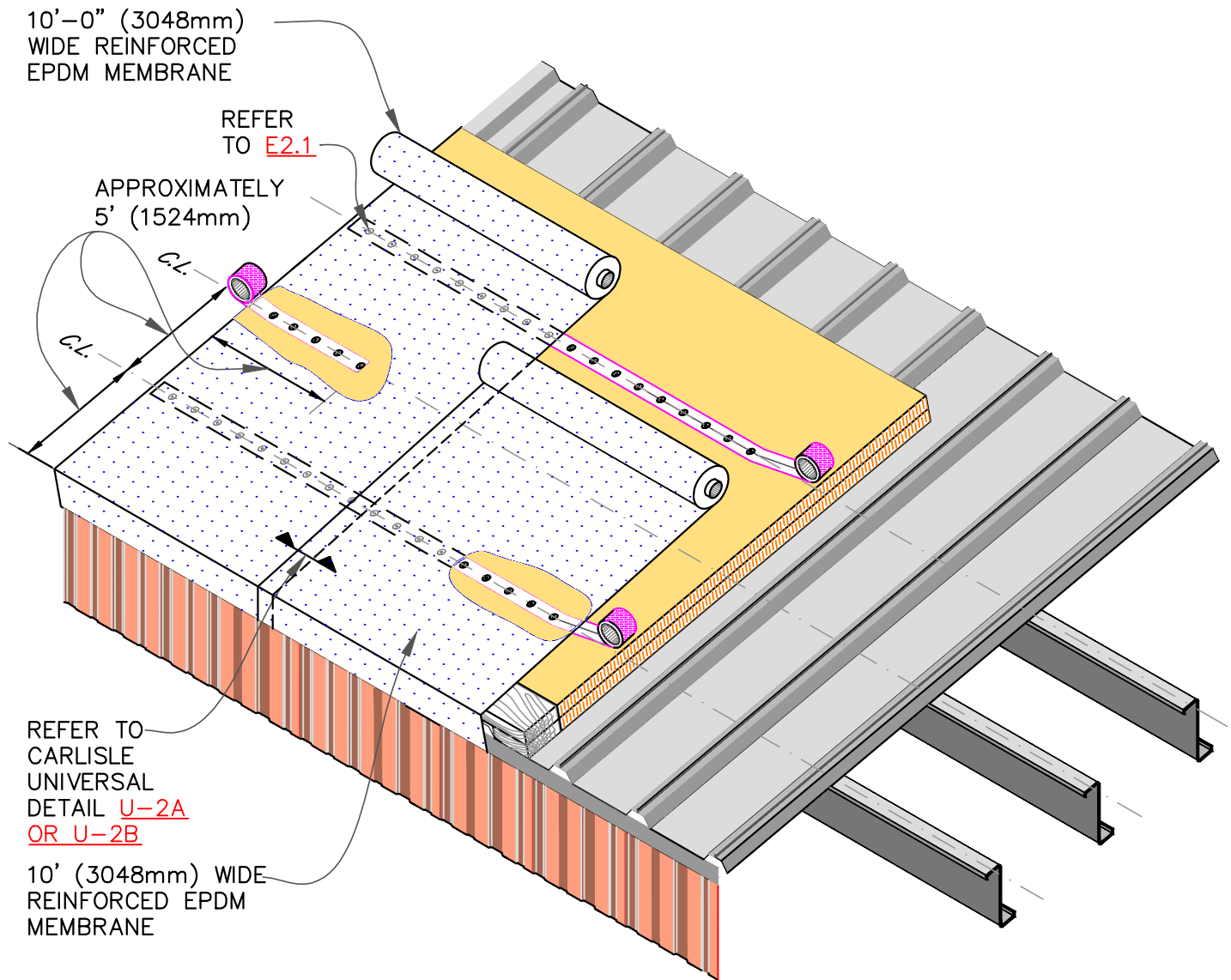

SHEET NO.
MR E2.1



NOTE:

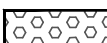

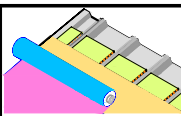

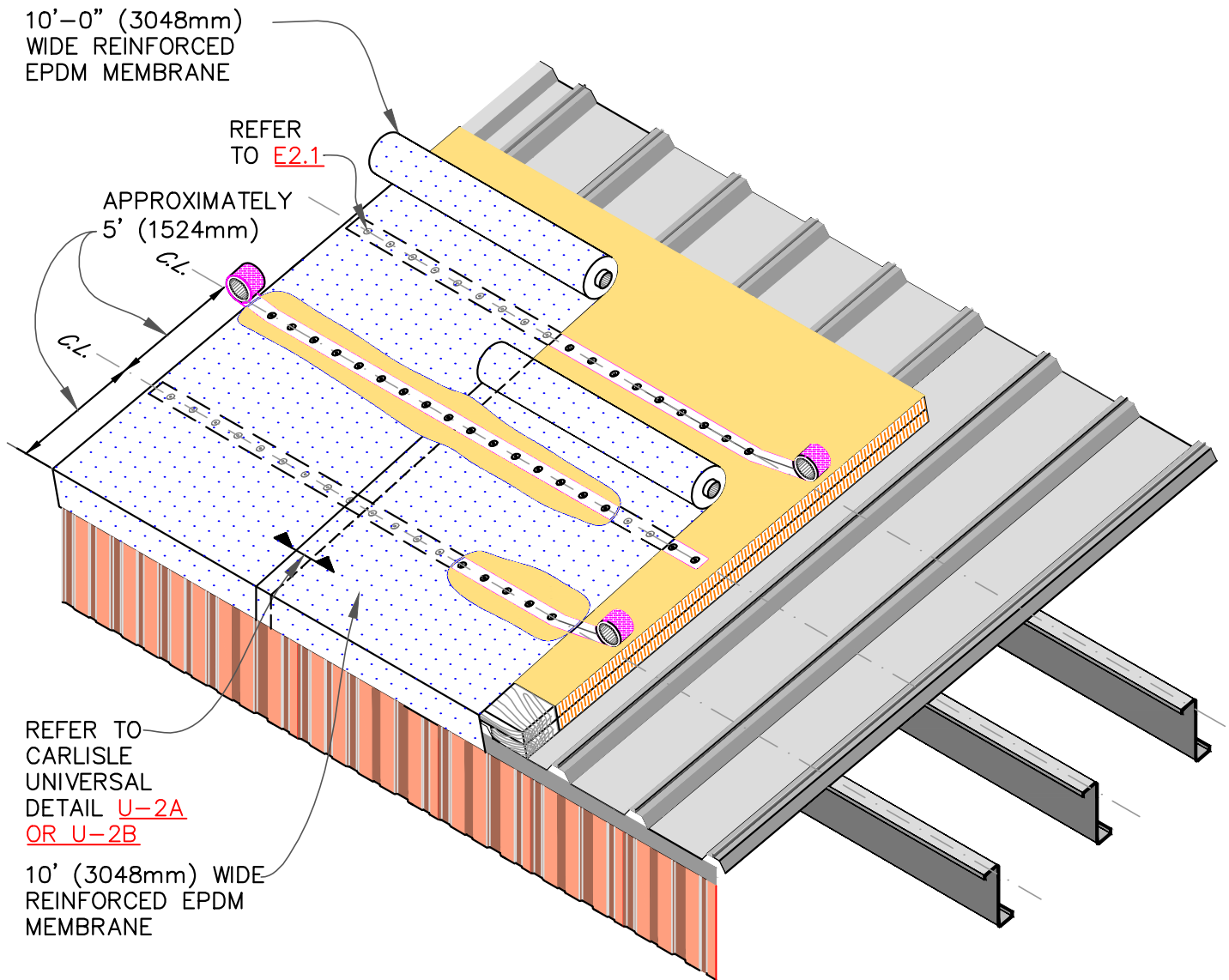
MEMBRANE SHEETS MAY BE INSTALLED PERPENDICULAR TO SLOPE.

MEMBRANE ATTACHMENT - WIND UP TO 100 MPH WIND ZONE			
	• HIGH DENSITY RECOVER BOARD		• ROOF MEMBRANE
	• IN-FILL INSULATION		• WOOD NAILER (BY OTHERS)
			• SEE DRAWING NOTE(S)
			SHEET NO. MR E2.2

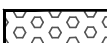

NOTE:

MEMBRANE SHEETS MAY BE INSTALLED
PERPENDICULAR TO SLOPE.

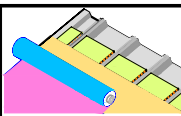
MEMBRANE ATTACHMENT - WIND UP TO 101-120 MPH WIND ZONE			
	• HIGH DENSITY RECOVER BOARD		• ROOF MEMBRANE
	• IN-FILL INSULATION		• WOOD NAILER (BY OTHERS)
			• SEE DRAWING NOTE(S)
			SHEET NO. MR E2.3

GUIDELINES FOR ROOF PERIMETER ZONES FOR MECHANICALLY FASTENED ROOF SYSTEM

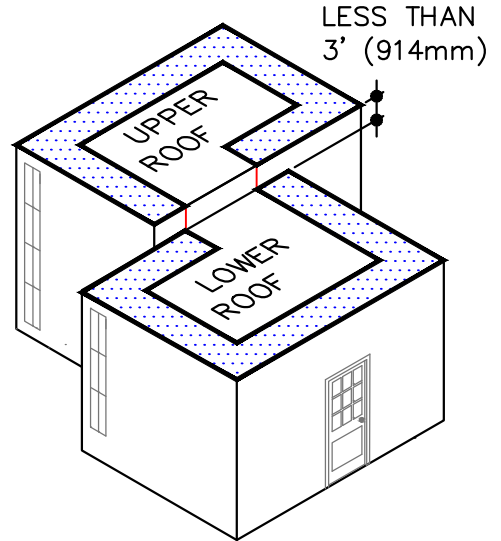
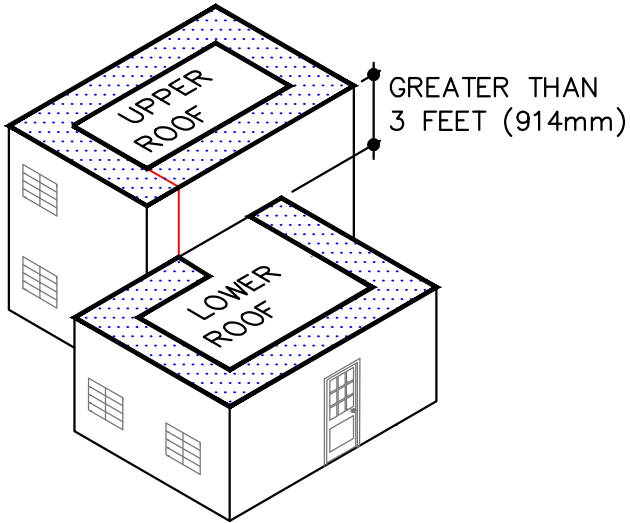



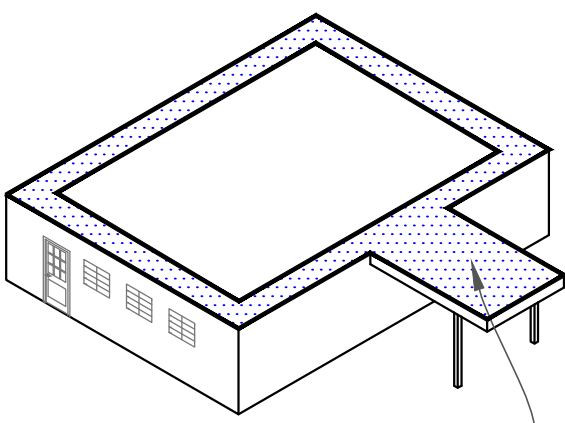
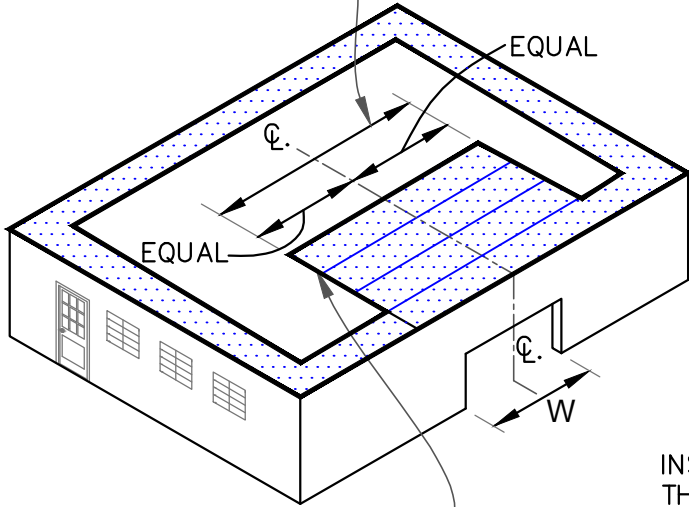

WIDTH (W) X 1.5

PERIMETER ZONES

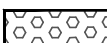

FOUR PERIMETER SHEETS CENTERED OVER LARGE OPENINGS.

INSTALL PERIMETER SHEETS OVER THE ENTIRE OVERHANG EXTENDING ONTO THE MAIN ROOF

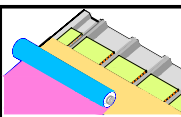
ROOF PERIMETER ZONES		SHEET NO.	
	• HIGH DENSITY RECOVER BOARD		• ROOF MEMBRANE
	• IN-FILL INSULATION		• WOOD NAILER (BY OTHERS)
			• SEE DRAWING NOTE(S)
			MR E2.4

(A) 1-1/2" (38mm) RING SHANK NAILS @ 6" (152mm) O.C. MAXIMUM

(B) HP FASTENERS @ 12" (305mm) O.C. OR RING-SHANK NAILS @ 4" (102mm) O.C. & STAGGERED 3/4" (19mm) O.C.

6" (152mm) WIDE PRESSURE-SENSITIVE CURED COVER STRIP IN CONJUNCTION WITH SURE-SEAL PRIMER

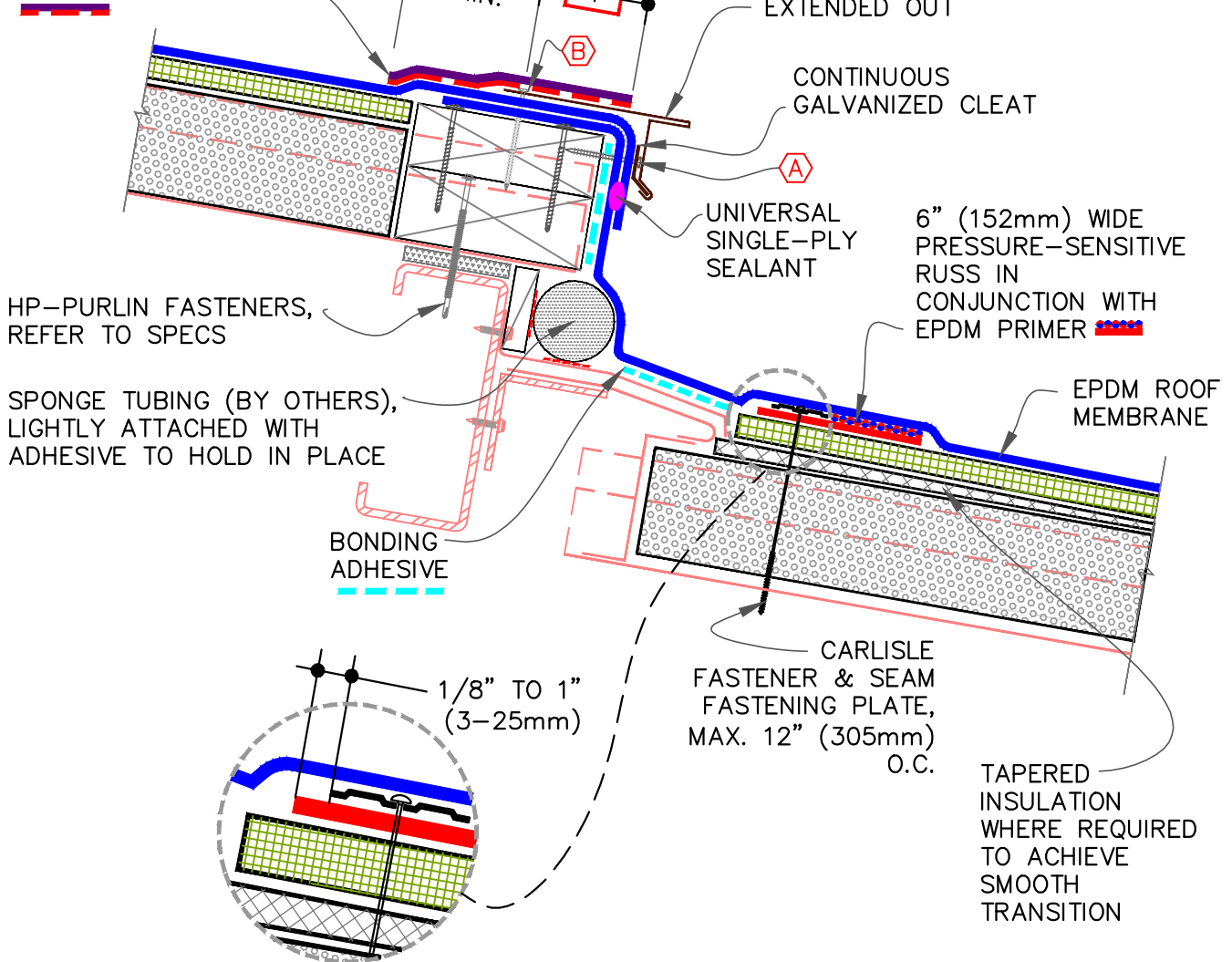

NOTE:

1. DECK FLANGE MUST BE TOTALLY COVERED WITH PRESSURE-SENSITIVE CURED COVER STRIP WITH MINIMUM 2" (51mm) COVERAGE PAST FASTENER HEAD.
2. REFER TO [MR Z1.1](#) & [MR Z1.2](#) AT THE END OF THIS SECTION.

EXPANSION JOINT AT STEP DOWN CONDITION		SHEET NO.	
• HIGH DENSITY RECOVER BOARD	• ROOF MEMBRANE		MR E3.1
• IN-FILL INSULATION	• WOOD NAILER (BY OTHERS)		
• SEE DRAWING NOTE(S)			

CAUTION: CONSULT WITH PROJECT DESIGNER OR STRUCTURAL ENGINEER FOR ADEQUATE SECUREMENT OF PLYWOOD AND REQUIRED VENTILATION.

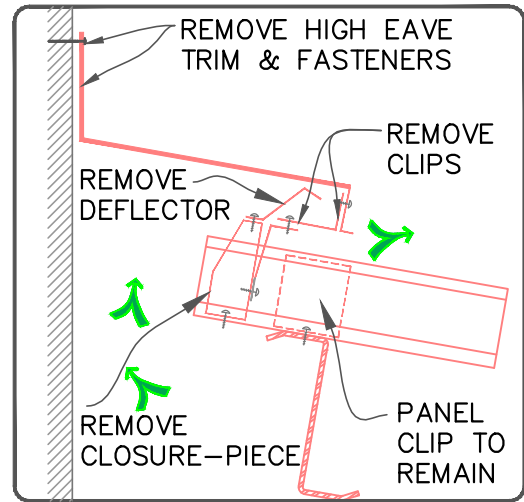

EXISTING VENTING AT RISING WALL

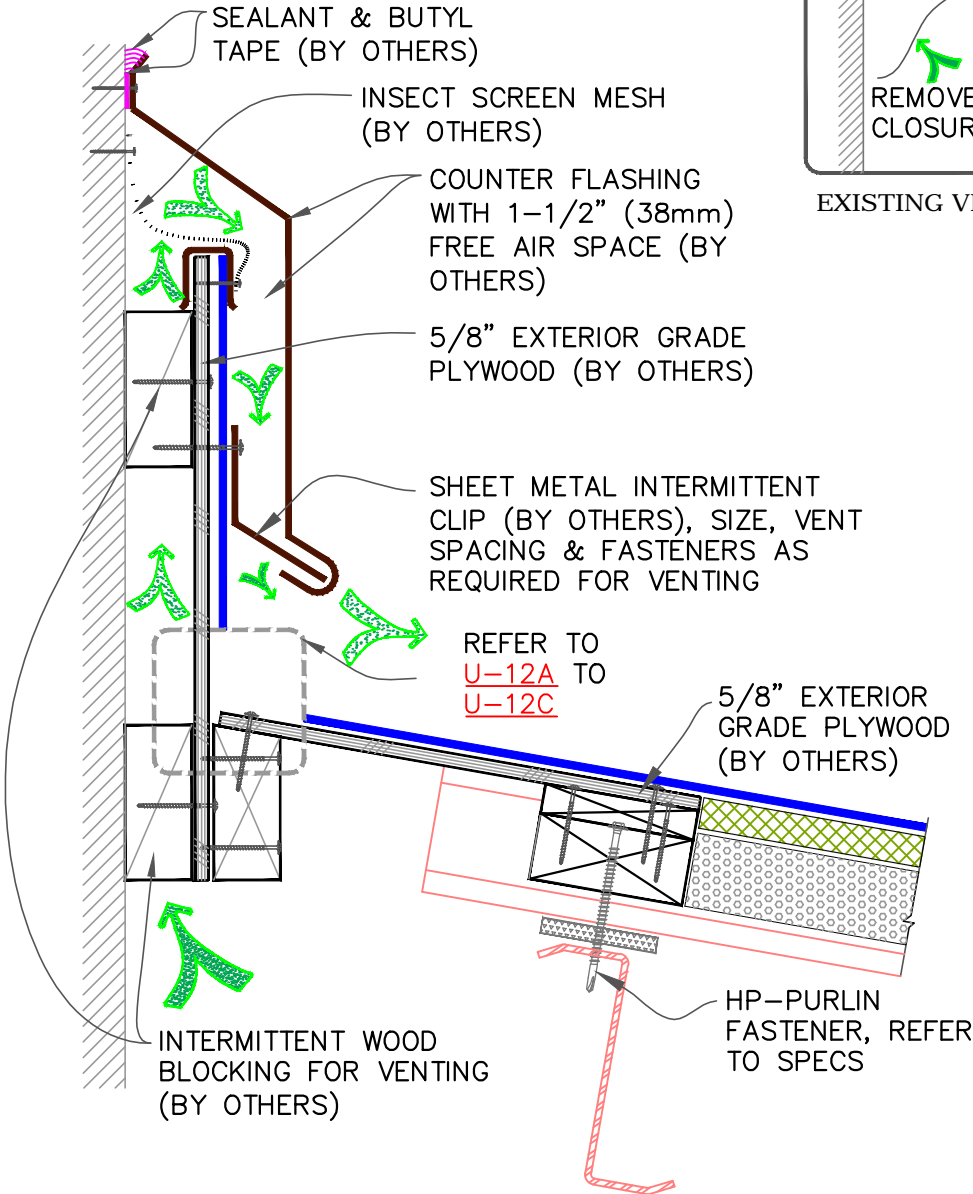

VERTICAL WALL - VENTED BASE DETAIL



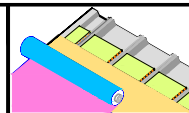

- HIGH DENSITY RECOVER BOARD
- ROOF MEMBRANE
- WOOD NAILER (BY OTHERS)
- IN-FILL INSULATION
- SEE DRAWING NOTE(S)

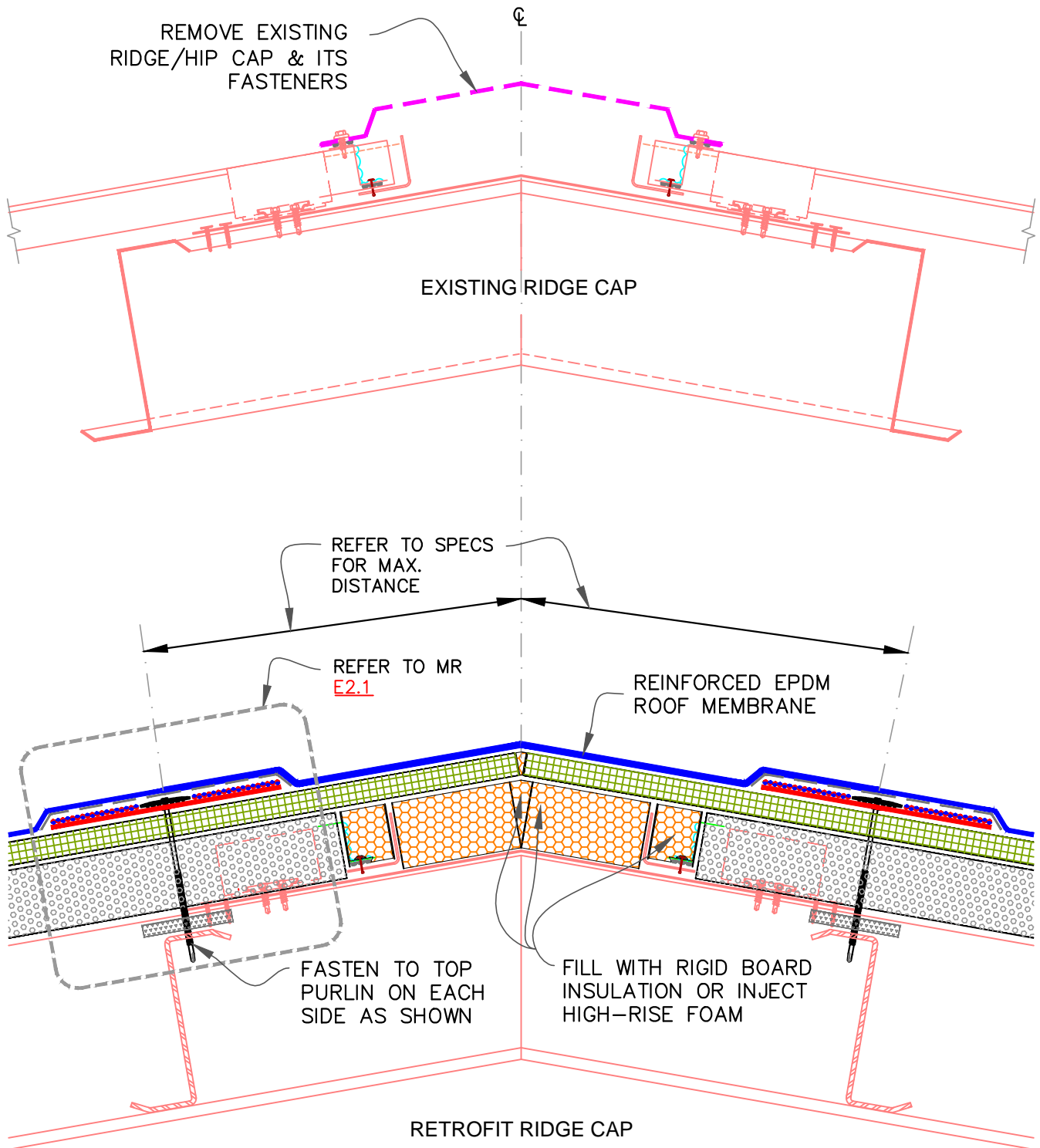

SHEET NO.
MR E12.1

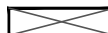

ROOF RIDGE / HIP - NON VENTED

-  • HIGH DENSITY RECOVER BOARD
-  • ROOF MEMBRANE
-  • WOOD NAILER (BY OTHERS)
-  • IN-FILL INSULATION
-  • SEE DRAWING NOTE(S)

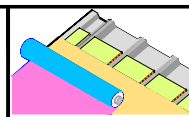

SHEET NO.
MR E22.1

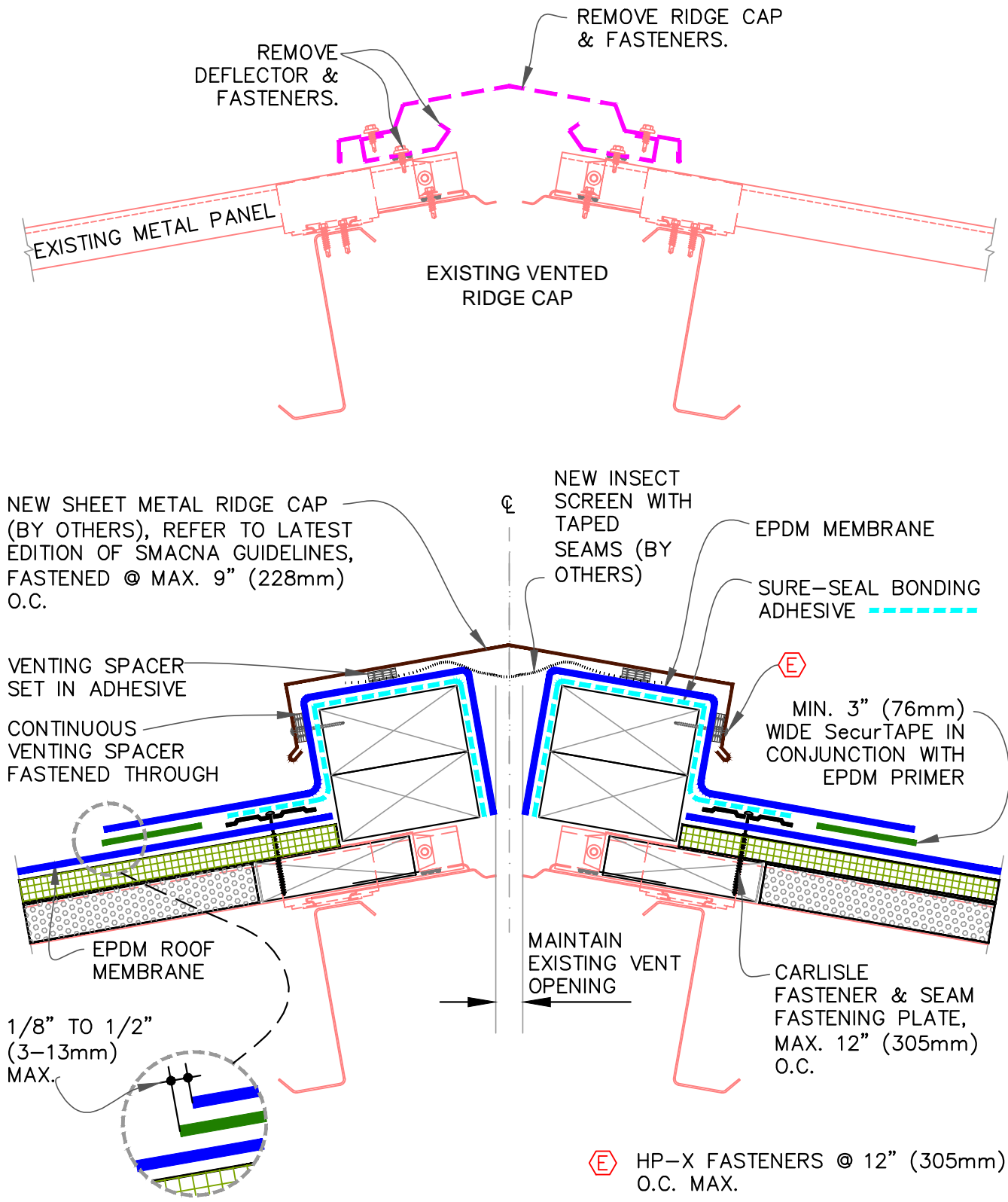

ROOF RIDGE VENTED		SHEET NO.	
	• HIGH DENSITY RECOVER BOARD		• ROOF MEMBRANE
	• IN-FILL INSULATION		• WOOD NAILER (BY OTHERS)
	• SEE DRAWING NOTE(S)		MR E22.2

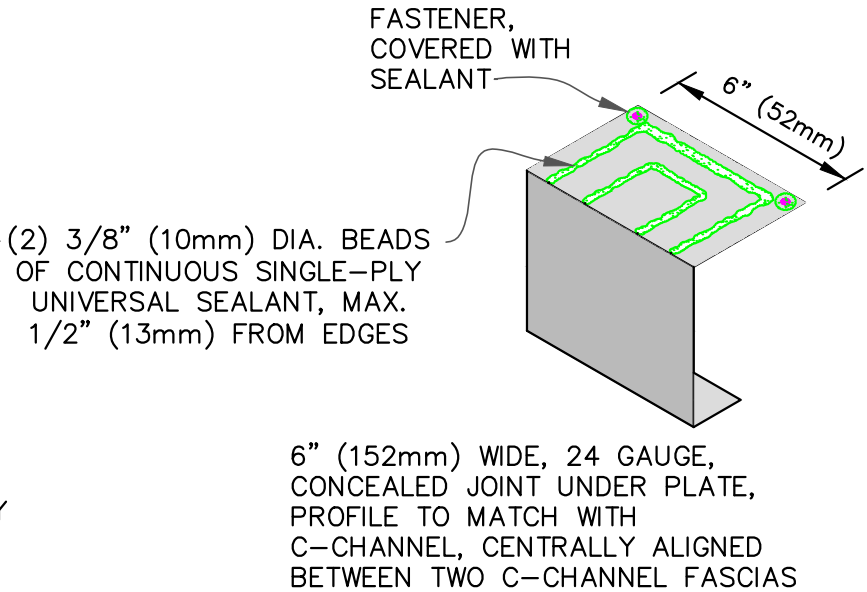
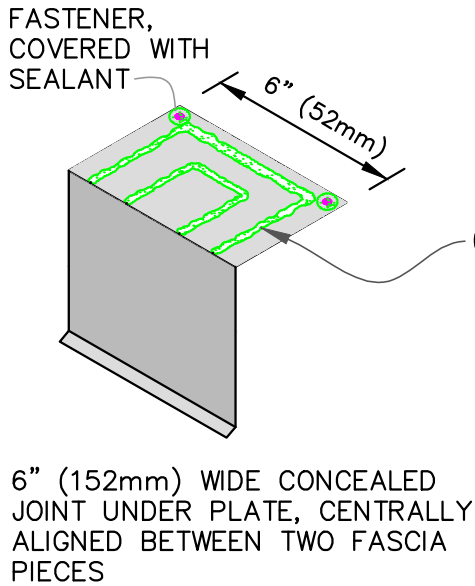
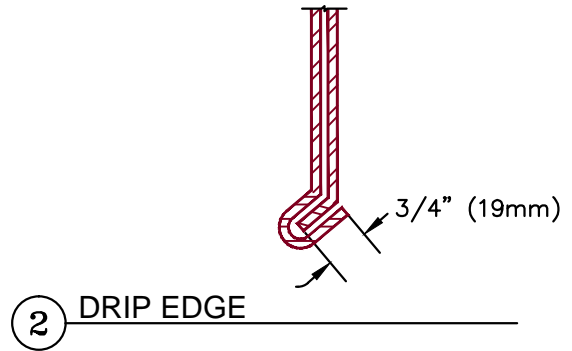
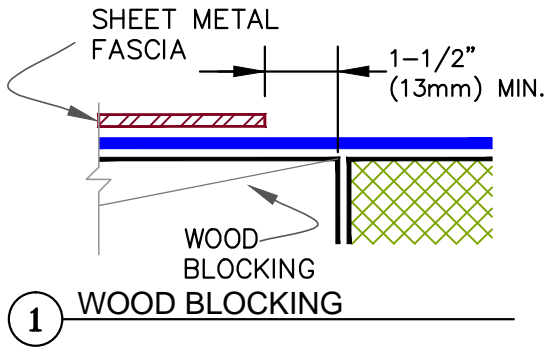

3 UNDER PLATE - TYP. FASCIA

4 UNDER PLATE: C-CHANNEL

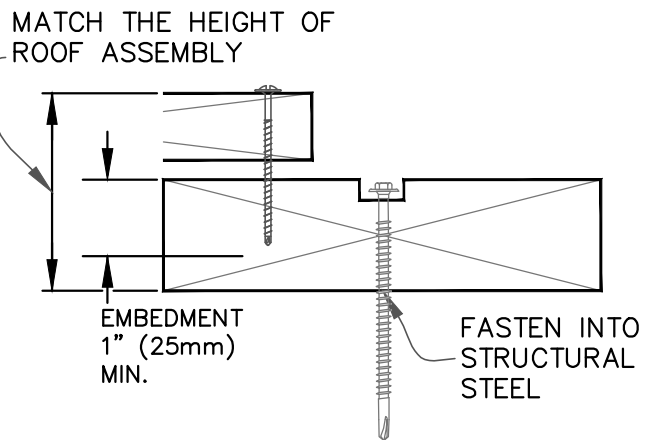
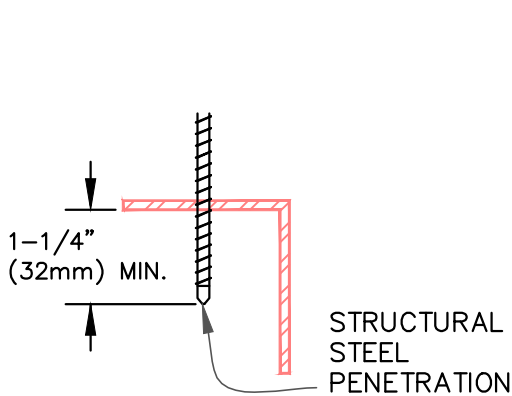

ENLARGED DETAILS

	• HIGH DENSITY RECOVER BOARD		• ROOF MEMBRANE
	• IN-FILL INSULATION		• WOOD NAILER (BY OTHERS)
			• SEE DRAWING NOTE(S)

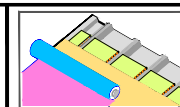

SHEET NO.
MR | Z1.1

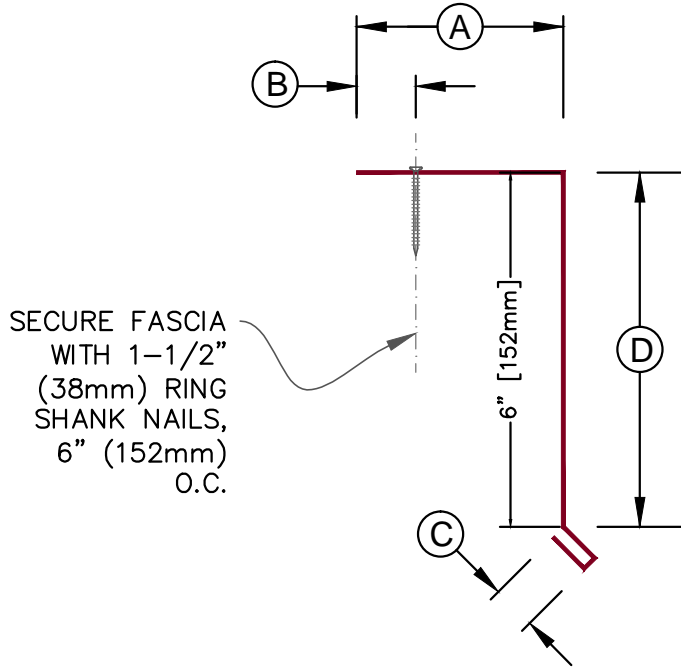

DIMENSIONS		mm
(A)	3-1/2"	28
(B)	1"	25
(C)	3/4	19
(D)	4" OR 6"	102 OR 152

NOTE:
ALL 1-1/2" (38mm) RING SHANK NAILS MUST HAVE 1" (25mm) MINIMUM EMBEDMENT INTO WOOD

(A) ES-1 COMPLIANT FASCIA PROFILE
24 GAUGE (0.59 mm) THICK - 10' (3048mm) LENGTH

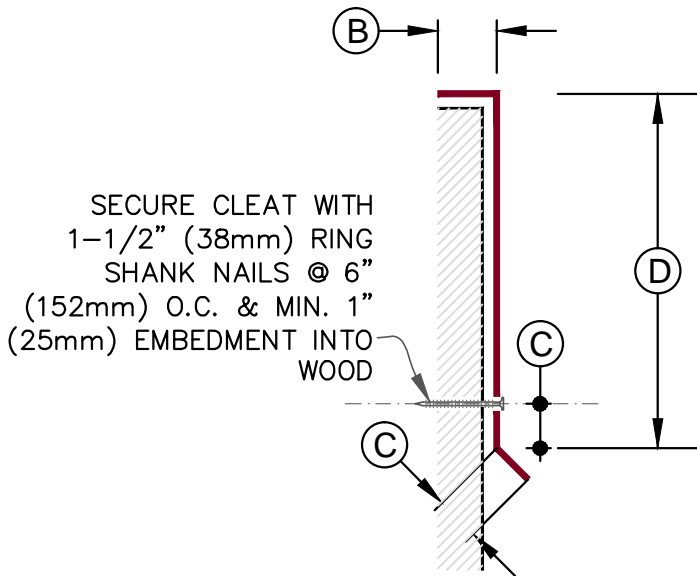

(B) GALVANIZED METAL CLEAT
22 GAUGE (0.75 mm) THICK

ES-1 COMPLIANT		
RE-1	424	PSF (POUNDS/SQUARE FOOT)
	62.62	(kilogram/sq.meter)
RE-2	614	pascals (Pa)
	435	PSF (POUNDS/SQUARE FOOT)
	64.24	(kilogram/sq.meter)
	629.95	pascals (Pa)

ANSI / SPRI ES-1 COMPLIANT FASCIA - SHOP FABRICATED		
• HIGH DENSITY RECOVER BOARD • IN-FILL INSULATION	• ROOF MEMBRANE • WOOD NAILER (BY OTHERS) • SEE DRAWING NOTE(S)	SHEET NO.